

iPECS

1000i Series IP Phone (SMB)

User Guide

Please read this user guide carefully before operating your phone.
Retain it for future reference.

iPECS is an Ericsson-LG Brand



Revision History

ISSUE	DATE	DESCRIPTION OF CHANGES
1.0	Feb., 2020	Initial Release
1.1	Oct., 2020	- Added the 1048ilss model
1.2	Sep., 2021	- Added the 1048idss model - Updated Network configuration - Added VPN configurations - Added Wi-Fi configurations: (1040i/1050i only)
1.3	Oct., 2022	- Added Bluetooth configurations: (1040i/1050i only)

Copyright© 2019 Ericsson-LG Enterprise Co., Ltd. All Rights Reserved

This material is copyrighted by Ericsson-LG Enterprise Co. Ltd. Any unauthorized reproductions, use or disclosure of this material, or any part thereof, is strictly prohibited and is a violation of Copyright Laws.

Ericsson-LG Enterprise reserves the right to make changes in specifications at any time without notice.

The information furnished by Ericsson-LG Enterprise in this material is believed to be accurate and reliable, but is not warranted to be true in all cases.

Ericsson-LG Enterprise and iPECS are trademarks of Ericsson-LG Enterprise Co., Ltd.

The contents of this document are subject to revision without notice, due to continued progress in methodology, design, and manufacturing. Ericsson-LG Enterprise shall have no liability for any error or damage of any kind resulting from the use of this document.

Table of Contents

1	Introduction	1
1.1	General.....	1
1.2	Feature Information	1
1.3	Entering Station Program Data Information	1
1.4	Feature Groupings.....	1
1.5	iPECS 1000i Phone Description	2
1.5.1	Phone Layout and Functions.....	2
1.6	1000i Installation.....	6
1.6.1	Global Provisioning	8
1.7	DSS Overview & Installation.....	9
1.7.1	1024idss overview.....	9
1.7.2	1048ilss overview	10
1.7.3	1048idss overview.....	11
1.7.4	DSS Installation.....	12
1.8	Wall Mount Installation.....	13
1.9	EHS Adaptor.....	14
1.10	Wi-Fi dongle	14
1.11	Entering Text	15
1.11.1	Phone Entering Text.....	15
1.11.2	System Entering Text.....	16
1.12	Bluetooth dongle.....	17
2	Using the LCD & Speakerphone	19
2.1	Using the LCD	19
2.1.1	1000i Series Phone Displays	19
2.1.2	Upper line and Flexible button icons	21
2.2	Using the Speakerphone	24
3	Receiving Calls.....	25
3.1	Answering a Call While Idle	25
3.2	Responding to a Call While Busy	25
3.3	Using Answering Machine Emulation (AME)	26
3.4	Differential Ring Signals	26
3.5	Answering Calls at Night.....	27
3.6	Answering Calls to Other Stations	27
3.7	Using Do-Not-Disturb (DND) to Block Incoming Calls	27
3.8	Forwarding Calls.....	28
3.8.1	Forwarding calls to another Station or Voice Mail	28
3.8.2	Forwarding callers to a Text Message	29
4	Placing Calls.....	30
4.1	Internal Calls.....	30

4.1.1	Using Camp-On when calling a busy station.....	30
4.1.2	Leaving a Message Wait Indication.....	31
4.1.3	Leaving a Voice Mail	31
4.2	External Calls	31
4.2.1	Placing external (Outside Line) calls	31
4.2.2	Waiting for the next available Outside line	32
4.2.3	Account Codes: Tracking External calls for billing	32
4.2.4	Disable dialing from your phone	33
4.2.5	Temporarily override dialing restrictions at a phone.....	33
4.3	Directory	34
4.3.1	Directory button and Search.....	34
4.3.2	Using System Speed Dial (System Directory)	34
4.3.3	Using Station Speed Dial (Personal Directory)	34
4.3.4	Using Dial by Name and Entering Your Name	35
4.3.5	Using Redial List	36
4.3.6	Using and Entering Saved Number Dial.....	36
4.3.7	Using Automatic Called Number Redial (ACNR)	36
5	Call Handling	37
5.1	Call Transfer: Sending a call to a different destination	37
5.2	Call Hold: Placing a call in a waiting state	37
5.3	Broker Call: Switching between two calls	38
5.4	Joining Multiple People in a Conference.....	38
5.4.1	Setting up a Conference Room	39
5.5	Call Park: Placing a call on Hold to Page	39
5.6	Two-Way Record: Recording a call	40
6	Send & Retrieve Messages.....	41
6.1	Responding to a Station Message Waiting Indication.....	41
6.2	Getting Voice Mail Messages	42
6.3	Sending and Receiving Short Text Messages	43
7	Remote System Access	44
7.1	Mobile Phone Extension	44
8	Misc. Features.....	45
8.1	Call Log	45
8.1.1	Call Log - Phone self option	45
8.1.2	Call Log – System serve option.....	47
8.2	Contrast	48
8.3	Background Music	48
8.4	Using Internal, External and Meet-Me Paging	48
8.5	Push-To-Talk (PTT) Page.....	49
8.6	Wake-Up Alarm	49
8.7	Alarm/Door Bell	50

8.8	System Voice Memo.....	51
8.9	Hot Desk.....	52
9	Display Menu.....	53
9.1	Menu Overview.....	53
9.2	Using the Menu	53
9.2.1	Phone Setting.....	53
9.2.2	Conference Room	55
9.2.3	ICM SMS	55
9.2.4	Network Configuration.....	56
9.2.5	Button Program	57
9.2.6	Attendant menu	57
9.2.7	Additional phone configurations	58
10	Features & Flexible Buttons	59
10.1	Entering Station Program Data.....	59
10.2	Assigning Features to Flexible Buttons	59
10.3	Web Manager	60
	Appendix A: User Program Code.....	69
	Appendix B: 1000i Series Model Specification	72
	Appendix C: Document abbreviations.....	74
	Appendix D: Open Source Software Notice.....	76

Regulatory Information

Important Safety Information

To prevent unexpected danger or damage please read this information before installing or attempting to repair you phone. Warning and Caution information is provided to alert the consumer of known dangers:



Warning: To reduce the possibility of electric shock, do not expose your phone to high humidity areas, such as a bathroom, swimming area, etc.



Warning

- Only trained and qualified service personnel should install, replace or service the phone.
- Do not spill liquid water on the phone. If so, disconnect the phone immediately and call the service center as this may result in fire or electric shock.
- If you see or smell smoke during use, disconnect the phone and call the service center immediately.
- If the power adaptor is used, do not touch the plug with wet hands. This may result in a fire, an electric shock or equipment damage.
- Do not use the phone during a thunderstorm. A lightning strike may result in fire, severe electrical or acoustic shock.
- Do not use the power adaptor if the power cord or wall outlet is damaged. This may result in fire or an electric shock.



Caution

- Ensure that children do not pull on phone cords. This may injure children or result in equipment damage.
- The earpiece houses a magnetic device that may attract pins or small metal objects. Keep the handset clear of such objects and check before use.
- Avoid placing the phone in an area that is excessively dusty, damp or subject to vibration.
- Choose a site for the phone that is well ventilated and dry.
- Do not plug multiple plug-packs into one power outlet. This may result in the plug overheating and may result in a fire or plug pack failure.
- Do not put heavy things on the phone.
- Do not drop or throw the phone.
- Static electricity discharge will damage electronic components.
- Keep out of direct sunlight and away from heat.
- No user-serviceable parts are inside. Do not insert a screwdriver or any metal objects into the phone. This may cause electric shock or damage the equipment and will render the warranty void.
- Clean the phone with a soft, dry cloth only. Do not use volatile liquids such as petrol, alcohol, or acetone as this may cause a fire or result in discoloration or damage to plastics. Do not clean with wax or silicon products as these may enter the equipment and cause operation to become unstable.

[EU] European Union Declarations of Conformity

Ericsson-LG Enterprise Co.,Ltd. declare that the equipment specified in this document bearing the “ CE” mark conforms to the Electromagnetic Compatibility Directive(EMCD,2014/30/EU) and Low Voltage Directive(LVD, 2014/35/EU).

Copies of these Declarations of Conformity (DoCs) can be obtained by contacting your local sales representative.

[USA/CSA] FCC/IC Interference Statement

This equipment has been tested and found to comply with the limits for a Class B digital device, pursuant to part 15 of the FCC Rules.

These limits are designed to provide reasonable protection against harmful interference in a residential installation.

This device complies with part 15 /RSS-GEN of the FCC/IC rules. Operation is subject to the following two conditions:

(1)This device may not cause harmful interference; and (2)This device must accept any interference received, including interference that may cause undesired operation.

(1)l'appareil ne doit pas produire de brouillage, et (2)l'utilisateur de l'appareil doit accepter tout brouillage radioélectrique subi, même si le brouillage est susceptible d'en compromettre le fonctionnement.

This equipment generates, uses and can radiate radio frequency energy and, if not installed and used in accordance with the instructions, may cause harmful interference to radio communications. However, there is no guarantee that interference will not occur in a particular installation.

If this equipment does cause harmful interference to radio or television reception, which can be determined by turning the equipment off and on, the user is encouraged to try to correct the interference by one or more of the following measures:

- Reorient or relocate the receiving antenna.
- Increase the separation between the equipment and receiver.
- Connect the equipment into an outlet on a circuit different from that to which the receiver is connected.
- Consult the dealer or an experienced radio/TV technician for help.

This Class B digital apparatus meets the requirements of the Canadian Interference-Causing Equipment Regulations, CAN ICES-3(B)/NMB-3(B)

Cet appareil numérique de la classe B respecte toutes les exigences du Règlement sur le matériel brouilleur du Canada.

CAUTION : Any changes or modifications in construction of this device which are not expressly approved by the party responsible for compliance could void the user's authority to operate the equipment.

ATTENTION: Tout changement ou modification dans la construction de cet appareil qui ne sont pas expressément approuvés par la partie responsable de la conformité pourraient annuler l'autorité de l'utilisateur à utiliser l'équipement. This Class B digital apparatus complies with Canadian ICES-003.

Disposal of your old appliance



- When the crossed-out wheeled bin symbol is attached to a product, it means the product is covered by the European Directive 2012/19/EU.
- All electrical and electronic products should be disposed of separately from the municipal waste stream via designated collection facilities appointed by government or the local authorities.
- The correct disposal of your old appliance will help prevent potential negative consequences for the environment and human health.
- For more detailed information about disposal of your old appliance, please contact your city office waste disposal service or the shop where you purchased the product.

Before Use

About this Guide

This guide is intended for users of the 1010i, 1020i, 1030i, 1040i and 1050i iPECS IP phone. The guide provides user-related information.

Introduction of the Document

This guide explains how to install and correctly use 1010i, 1020i, 1030i, 1040i and 1050i phones. Product figures and screen images used in this guide may be changed without notice for quality improvement.

Explanation of Symbol or Word

The following are symbols used in this guide. Information presented with these symbols must be observed for the correct use of your IP phone.



CAUTION

This mark warns of a situation in which light injury or product damage (hardware, software or data damage) may occur if the instructions are not followed.

NOTE

A note provides additional explanation, emphasis on important information or reference for related information, which is required for the correct use of the phone.

1 Introduction

1.1 General

Your telephone is connected to an advanced-technology, highly versatile, fully featured telecom system designed to make office communications easy and productive.

Employing state-of-the-art Voice over Internet Protocol (VoIP) technology, voice and data converge on a single IP packet network. Because each iPECS Phone is an IP appliance, it can be moved easily throughout the office wherever there is a LAN connection and maintain normal operation.

1.2 Feature Information

We have taken every effort to make this user guide simple and straightforward. The guide starts with the simpler operations of the iPECS Phone Speakerphone, moves on to receiving and placing calls, and then to more advanced features. Each section includes a brief and basic description of each feature and step-by-step operation instructions.

The operations shown in this guide use the System's base default Numbering Plan. Your specific Numbering Plan may be different. Some features may not be available for you to access or may be subject to certain limitations based on the set-up of the System. Please consult with your System Administrator for further information.

NOTE

Under certain operating conditions, this equipment may not be able to make emergency calls. Alternative arrangements should be made for access to emergency services.

1.3 Entering Station Program Data Information

A special code set is available for iPECS Phone users to assign certain attributes such as Authorization Codes (Passwords). After entering the User Program mode, you dial the codes to select the attribute and setting. Once selected, the setting is saved.

A list of the User Program codes, the feature/function and inputs required are available from your system administrator. Refer to section "Appendix A: User Program Code" for details.

1.4 Feature Groupings

Every effort has been taken to divide the features into a logical and consistent sequence so that features can be quickly located. Features have been divided into groups, Receiving Calls, Placing Calls, etc. Within each group, features are arranged according to the difficulty of operation and frequency of use.

1.5 iPECS 1000i Phone Description

The iPECS 1000i series phones incorporate the latest in VoIP technology and user interface to provide a cost effective, simple to use, productive communications tool.

Each 1000i phone includes an LCD, fixed and flexible buttons with LEDs, Navigation keys, and full-duplex speakerphone. As shown in the layouts that follow the size of the LCD, number of flexible buttons and softkeys varies for each model. Refer to section “Appendix B: 1000i Series Model Specification “ for details.

- The 1010i includes a 4-line 132 by 64 dot graphic LCD, 4 flexible buttons and 3 softkeys.
- The 1020i includes a 4-line 132 by 64 dot graphic LCD, 8 flexible buttons and 3 softkeys.
- The 1030i includes a 6-line(Max.) 320 by 240 dot graphic LCD, 6 flexible buttons and 3 softkeys.
- The 1040i includes a 6-line 480 by 320 dot graphic LCD, 8 flexible buttons and 3 softkeys.
- The 1050i includes an 8-line 480 by 272 dot graphic LCD, 12 flexible buttons and 3 softkeys.

NOTE

Features and functions of your iPECS are accessed using the Fixed or Flexible buttons, Soft keys or dial codes entered from the dial pad.

1.5.1 Phone Layout and Functions

1.5.1.1 Phone Layout

The figures below present line drawings of the front of each 1000i series phone identifying major elements of the user interface. As shown, the layouts of the 1010i, 1020i, 1030i, 1040i and 1050i are slightly different.

1010i Layout

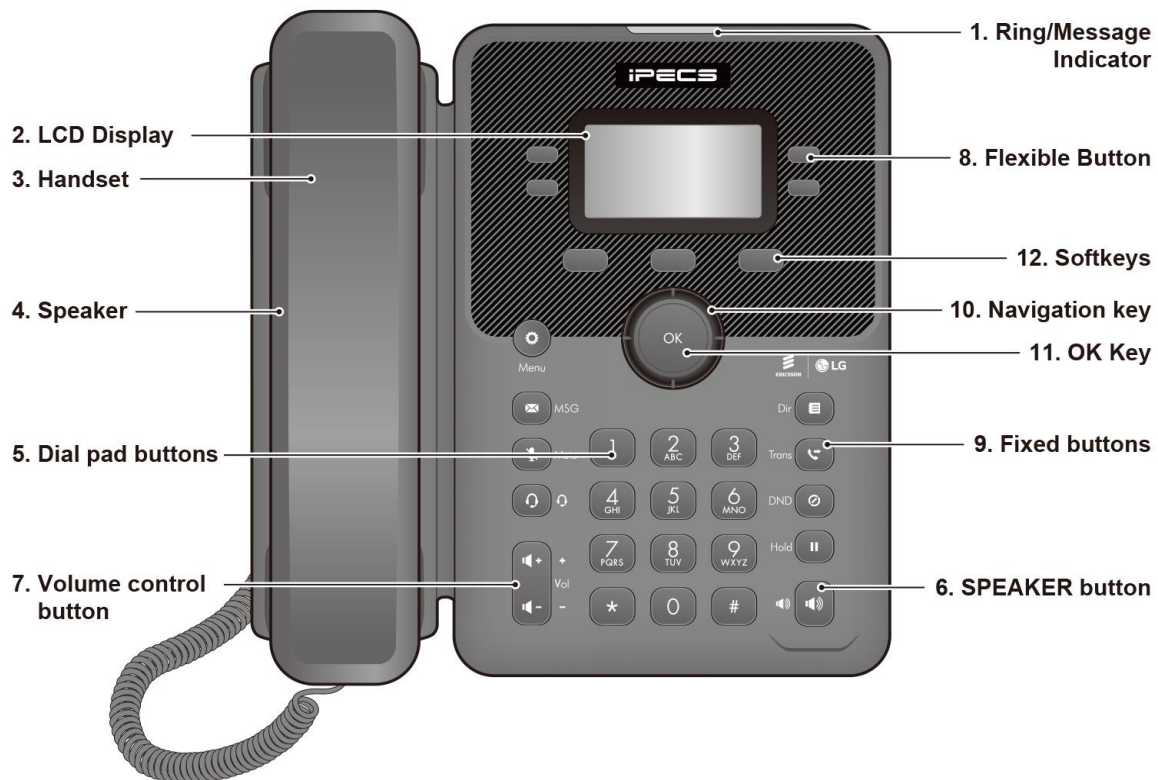

Figure 1.5.1-1: 1010i Front

1020i Layout

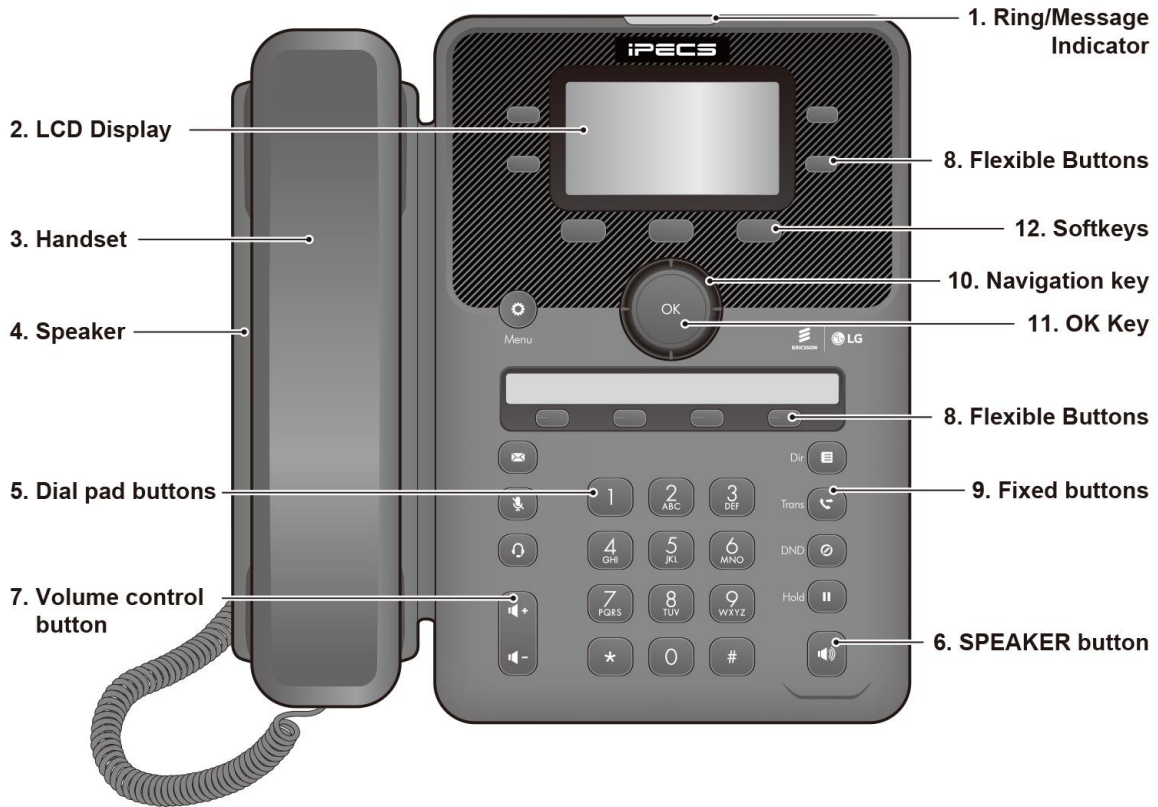

Figure 1.5.1-2: 1020i Front

1030i Layout

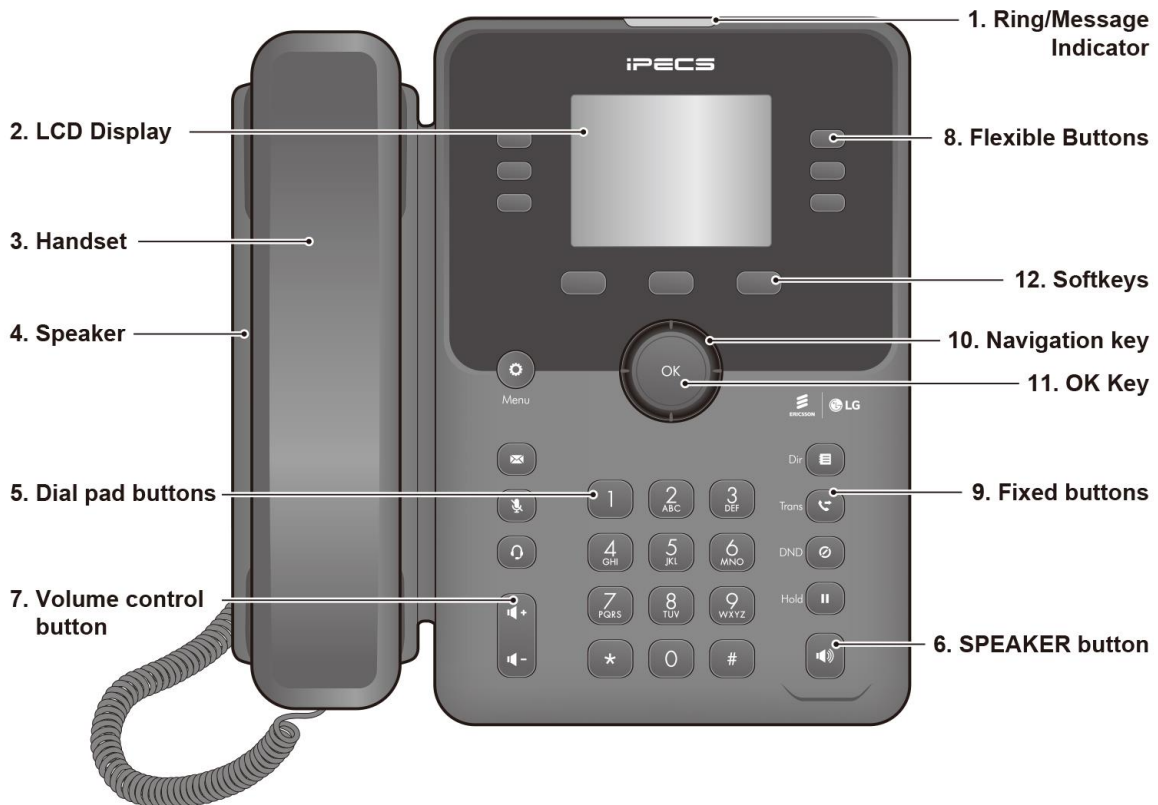

Figure 1.5.1-3: 1030i Front

1040i Layout

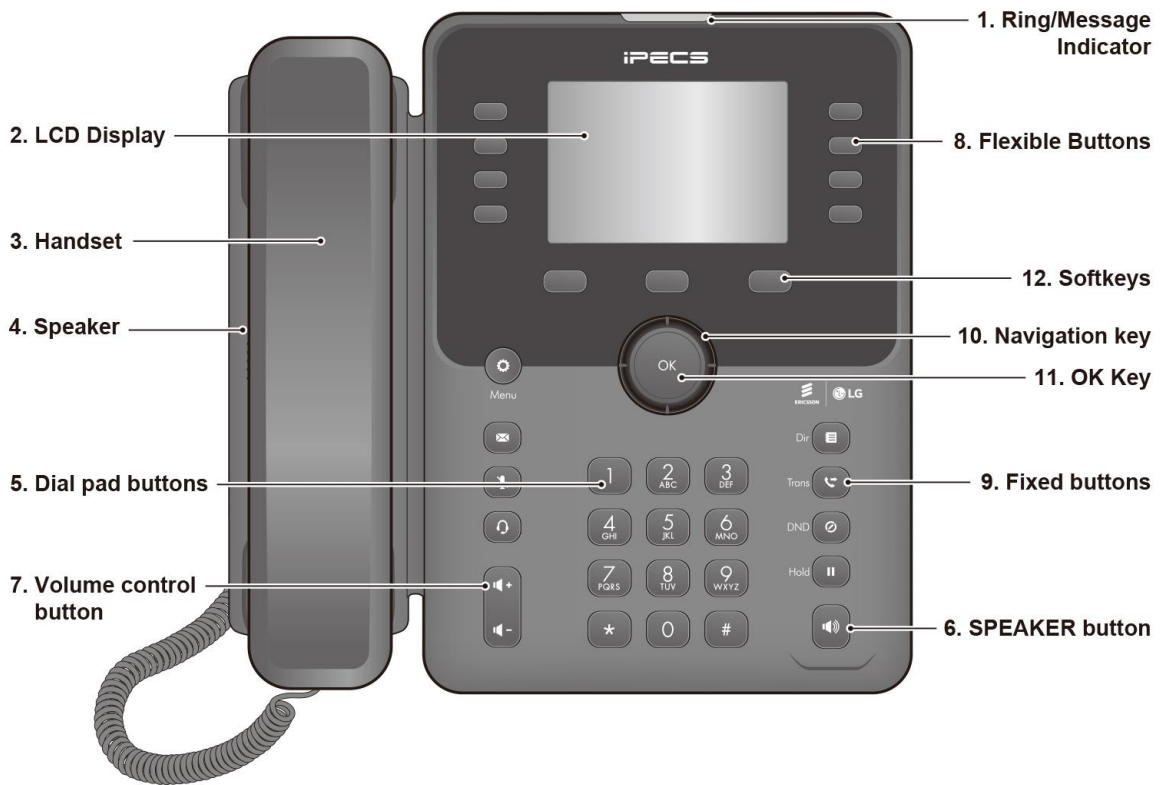

Figure 1.5.1-4: 1040i Front

1050i Layout

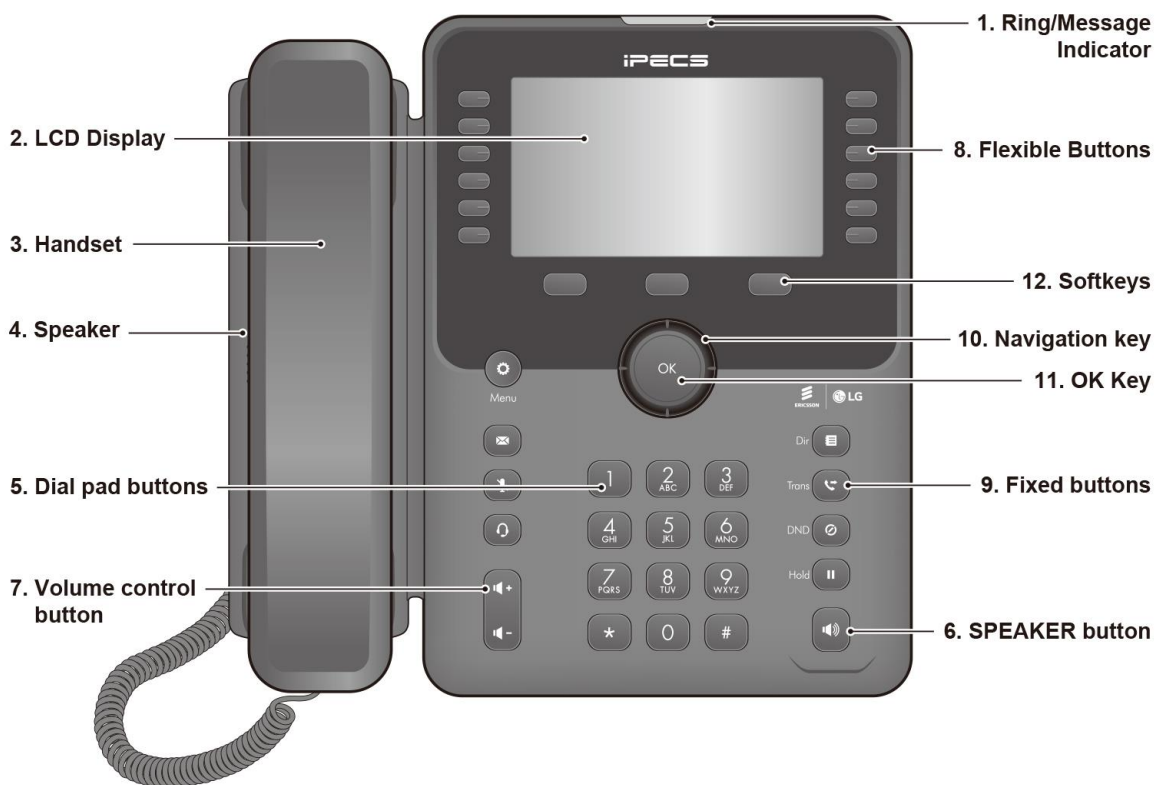









Figure 1.5.1-5: 1050i Front

1.5.1.2 Functions

Below is a brief description of the elements called in the 1000i series phone diagram above.

1. **Ring/Message Indicator:** Flashes when receiving a new call or you have a new message waiting.
2. **LCD Display:** Displays your phones status, dialing directories, and text message information.
3. **Handset:** Use to answer a call using the handset.
4. **Speaker:** Delivers ringing and other signals, and lets you hear the caller's voice in Speakerphone mode.
5. **Dial pad buttons:** Use to dial a number, select a menu item, or input a value.
6. **Speakerphone button:** Toggles the IP phone Speakerphone on and off. The button illuminates when the Speakerphone is active, or the phone is in menu mode (Except 1010i).
7. **Volume control button:** Use to adjust Ring, Headset, Handset, and Speaker volume.
8. **Flexible buttons:** Assigned as Line or feature access button.
 - 1010i has 4-flexible buttons.
 - 1020i has 4-flexible buttons with 3 pages and 4 flexible buttons with a paper label, total 16 buttons.
 - 1030i has 6-flexible buttons with 3 pages, total 18 buttons.
 - 1040i has 8-flexible buttons with 3 pages, total 24 buttons.
 - 1050i has 12-flexible buttons with 3 pages, total 36 buttons.
9. **Fixed buttons**
 - Menu () button: Accesses the menu for display and changes to the IP Phone configuration.
 - Transfer () button: Transfers the current active call. The button switches the dial pad input mode (A, a, * or 1). The dial pad mode displays in the upper-right corner.
 - Directory () button: Accesses your private or public directory for speed dialing.
 - Message () button: When the MWI LED indicates you have a message, use to access your Voice Mailbox.
 - DND () button: Use to activate DND (Do Not Disturb) so that your phone will not ring. The button also deletes the last character of an input in the menu mode.
 - Headset () button: When using a headset, this button toggles the headset state. When the headset is active, the button LED illuminates red and the Headset Icon will be displayed for 1010i.
 - Hold () button: Use to place a call on Hold. Also, use to access a held call. In menu mode, it saves your inputs.
 - MUTE () button: Toggles audio from the microphone to the connected party on and off.
10. **Navigation key**
 - Left: Use to move the previous group of softkey.
 - Right: Use to move the next group of softkey.
 - Up: Scrolls through the phone's menu options upward.
 - Down: Scrolls through the phone's menu options downward.
11. **OK Key:** Selects the highlighted choice when navigating through a menu. In 1030i, 1040i and 1050i, during a call, Pop-up display and call information can be toggled using "OK" button. Pop-up disappear and call information display in the top bar.
12. **Softkeys:** Softkeys are interactive, changing function based on the status of the phone.

1.6 1000i Installation

The 1000i Phones are shipped with the 1000i Phone, handset and coil cord, adjustable foot-stand, 1.5-meter (~5-foot) Cat 5 cable terminated in RJ-45 connectors, and the Quick Guide.

An optional AC/DC adaptor is available for use when the network connection does not provide power to the phone (support IEEE 802.3af PoE -Power over Ethernet-).

Several other options including DSS(Refer to section "1.7 DSS Overview & Installation")and wall mounting(Refer to section "1.8 Wall Mount Installation") are available.

The phone has a number of connections available including the handset and LAN connection, which are required. Connections to your desktop PC, headset and optional power adaptor are incorporated in the phone design.

To install the phone;

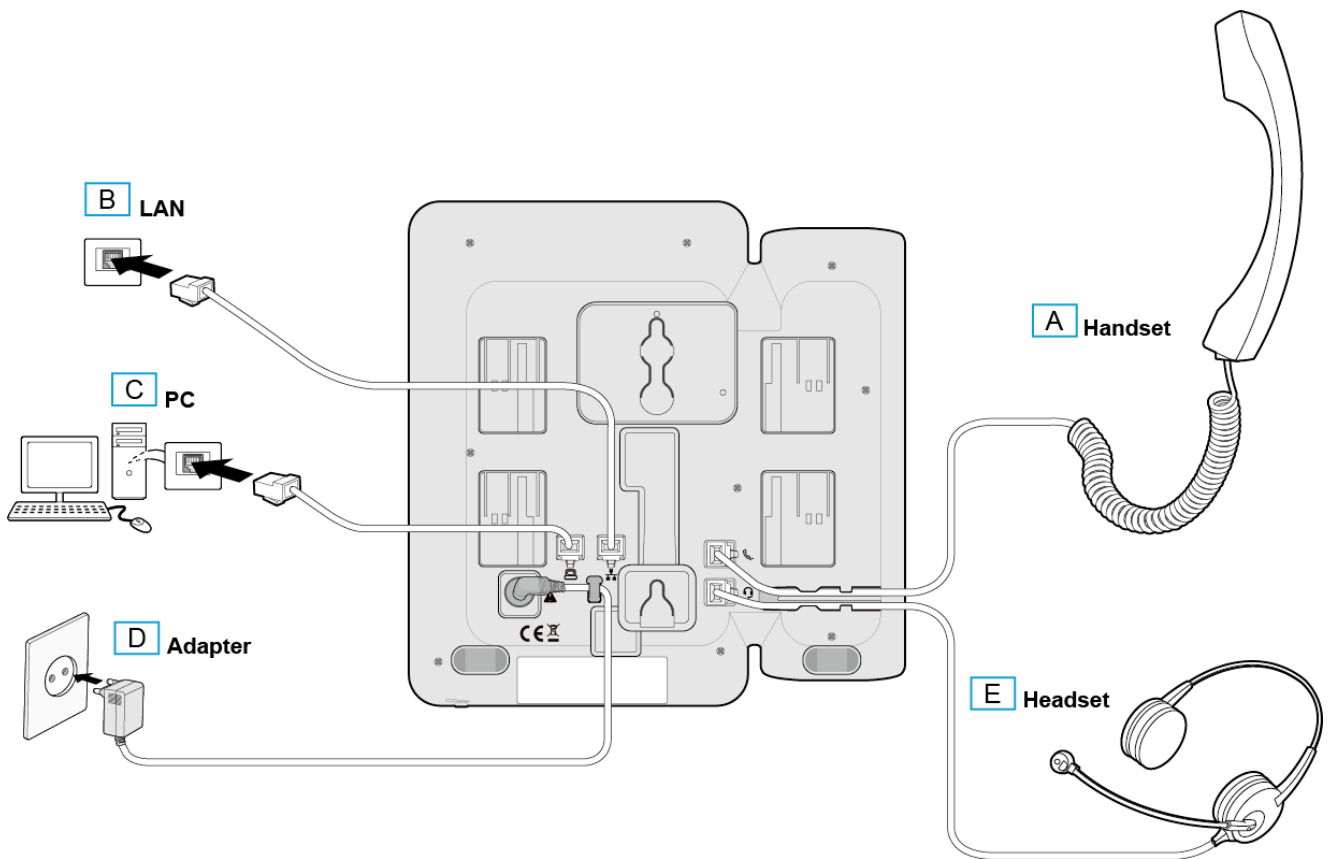

Figure 1.6: 1000i Installation

- 1) If needed install the DSS assembly as described in "1.7 DSS Overview & Installation" section.
- 2) Insert the connectors of the coil cord into the handset and phone handset port as shown in A.
- 3) Insert the provided Cat 5 cable into the network connection of the phone and the LAN wall jack as shown in B.
- 4) When needed, your desktop PC can be connected to the PC LAN port of the phone. Connect a Cat 5 cable (not provided) between the PC's LAN port and the PC LAN port of the 1000i phone as shown in C.

- 5) If your LAN port does not support Class 2 Power over Ethernet (PoE), you must install the optional AC Power adaptor. Note do not connect the power adaptor if your port does support PoE. Connect the DC output of the adaptor into the phone and the AC plug into a standard AC power outlet as shown in D. Consult with your system administrator to determine if you must install the AC power adaptor. You may need to contact your local ELG-Enterprise representative for the appropriate power adaptor for your region.



Caution

- To power your phone, use either PoE or the AC adaptor, not both.
 - Use the Ericsson-LG Enterprise approved AC power adaptor only. The AC adaptor is ordered separately.
- 6) A compatible headset may be connected to the Headset jack in the bottom of the phone. As shown in E, connect the headset plug into the headset jack. The 1000i phones are compatible with several headsets. Please consult with your local Ericsson LG-Enterprise representative for a list of headsets compatible with the 1000i.

The 1040i/1050i supports USB Headset. If a USB Headset is plugged in, the Headset function operates as a USB Headset.

NOTE: If you plug in or unplug the USB Headset during a call, it will operate from the next call.
 - 7) The phone includes a foot stand that can be installed to provide a 35° or 50° angle of the face of the phone. If the phone is not wall mounted, install the foot stand at the desired angle. If wall mounting, do not install the foot stand.

NOTE

Once installation is complete, the phone may require configuration of the network parameters before becoming operational. These parameters should be modified by a trained technician only.

1.6.1 Global Provisioning

If you turn on the phone, it will show a “Global Provisioning” menu. You don’t need to use the Global Provisioning in the SMB, so you should skip this menu.

- 1) Press the “NO” soft key when the below is shown.

Global Provisioning	
YES	NO

- 2) If you press the “YES” soft key by mistake from the above screen, then press the “CANCEL” soft key from the first screen and press the “EXIT” soft key from the second screen.

DHCP SEARCHING...
CANCEL

IP Address
DELETE EXIT DHCP

1.7 DSS Overview & Installation

1.7.1 1024idss overview

The 1024idss provides the 24 additional flexible buttons. The flexible buttons on the DSS are used as with the flexible buttons on the phone proper and can be assigned for any of the flexible button functions. One 1024idss can attach to an 1020i, 1030i ,1040i or 1050i phone, and can be placed on your desktop or can be wall-mounted with the phone.

The 1024idss is described as follows and shown in below figure.

- The 1024idss has 24 flexible buttons with tri-color LED. The 1024idss uses a paper label for the button designations.

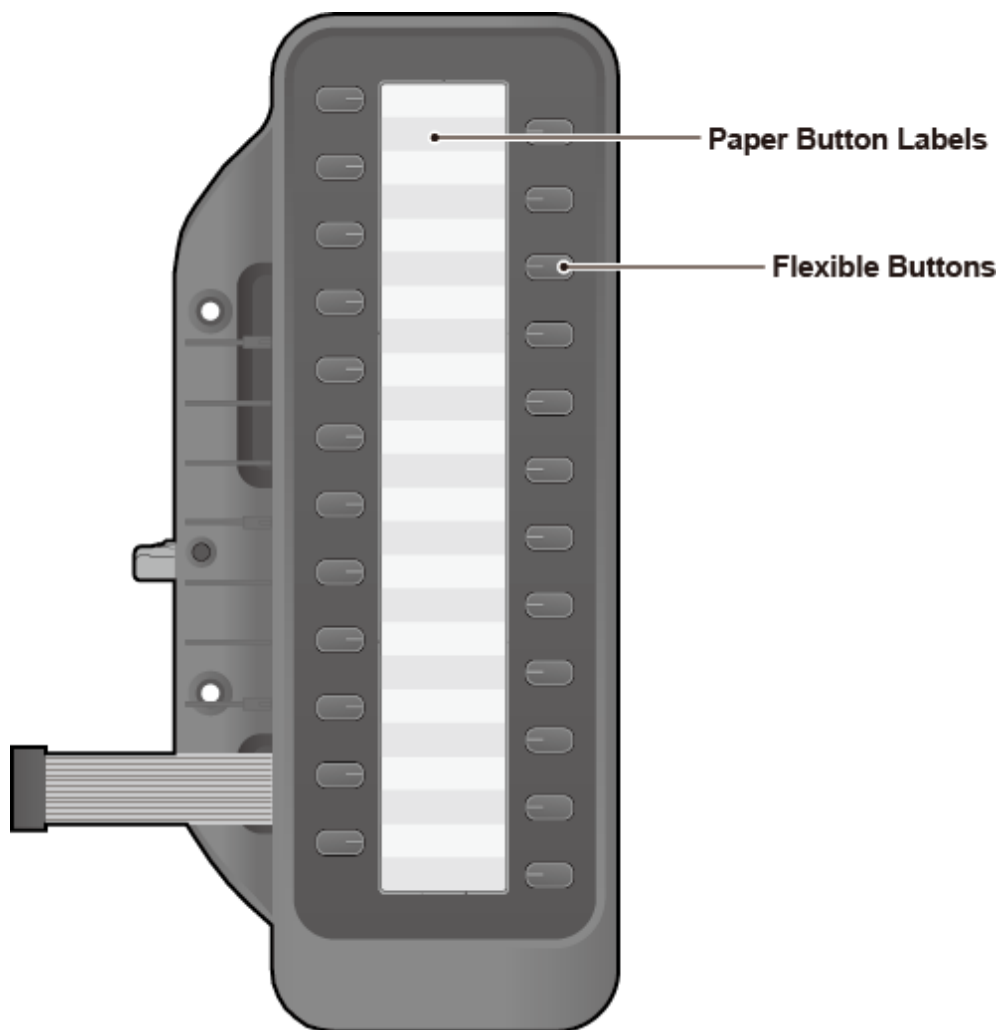

Figure 1.7-1: 1024idss



Caution

To avoid damaging the Phone or DSS, remove power from the phone before installing a DSS.

1.7.2 1048ilss overview

The 1048ilss provides the 2x24 flexible buttons that can be programmed to connect with an IP phone. You can connect up to three 1048ilss to the phone (except the 1010i), and can be placed on your desktop or can be wall-mounted with the phone.

NOTE

The iPKTS phone can connect up to three 1048ilss, but the 1048ilss cannot be used with 1024idss or 1048idss.

The 1048ilss is described as follows and shown in below figure.

- The 1048ilss provides the 2x24 flexible buttons with tri-color LED

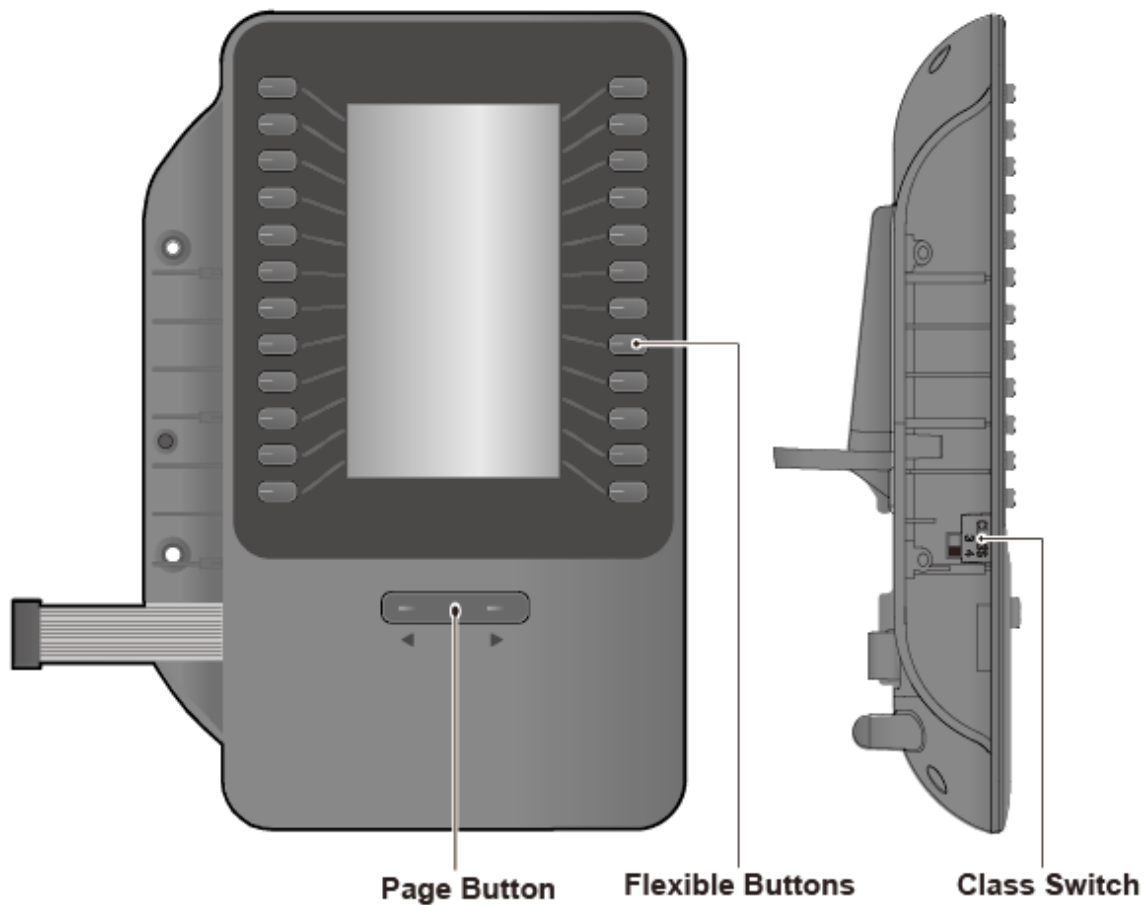

Figure 1.7-2: 1048ilss



Caution

Disconnect the power cable or remove the network cable to ensure that your phone is Off. Only a peripheral device can be connected to the AEM port. (1048ilss or EHSA)

USB Charging from the Phone

When charging using the phone's USB port, be sure to connect the Adaptor to the phone.(1040i,1050i only)

1.7.3 1048idss overview

The 1048idss provides 48 flexible buttons that can be programmed to connect with an IP phone. You can connect up to four 1048idss to the phone(except the 1010i), and can be placed on your desktop or wall-mounted with the phone.

NOTE

The iPKTS phone can connect up to four 1048idss, but the 1048idss cannot use with 1024idss or 1048ilss.

The 1048idss is described as follows and shown in the below figure.

- 1048idss: 48 flexible buttons with tri-color LED

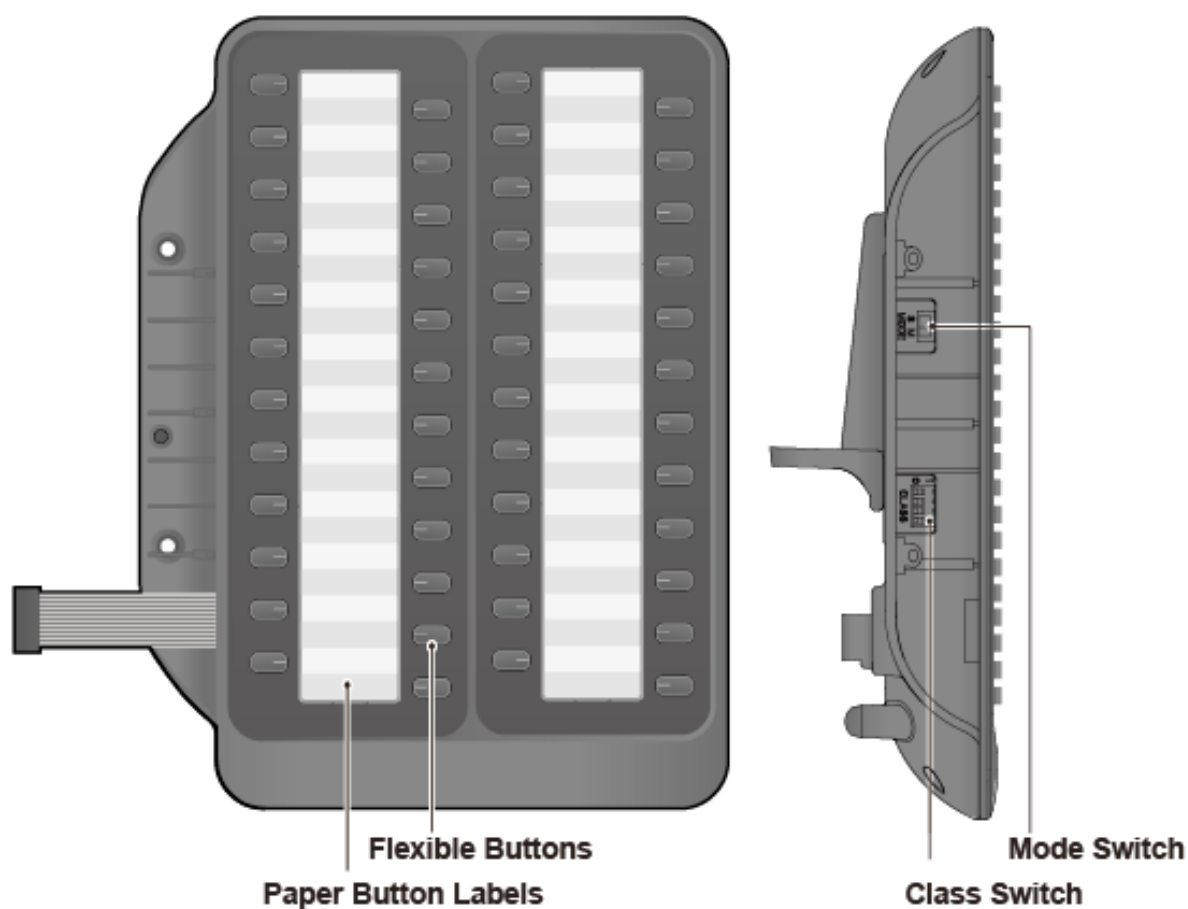

Figure 1.7-3 1048idss

Caution

Disconnect the power cable or remove the network cable to ensure that your phone is Off. Only a peripheral device can connect to the AEM port. (1048idss or EHSA)

USB Charging from the Phone

When charging using the phone's USB port, be sure to connect the Adaptor to the phone. (1040i,1050i only)

1.7.4 DSS Installation

The DSS should be installed on the phone prior to making any connections to the phone. This simplifies the installation for 1030i Phone and 1024idss. You can install the 1048ilss,1048idss in the same way.

For more detailed installation instructions, Scan the QR code that is printed on the product label of 1024idss or 1048ilss,1048idss to refer to a Quick installation Guide.

To install the DSS

- 1) First, assure the phone is NOT connected to power. For convenience, you may wish to remove the handset and foot-stand; this simplifies the DSS installation.
- 2) Align the DSS and phone as shown in the drawing.
- 3) Connect the DSS Connecting Cable to the phone.
- 4) Push the DSS into the phone until the DSS is fully engaged.
- 5) Insert the screws provided through the screw tabs in the DSS and tighten the screws into the phone. Do not over-tighten.

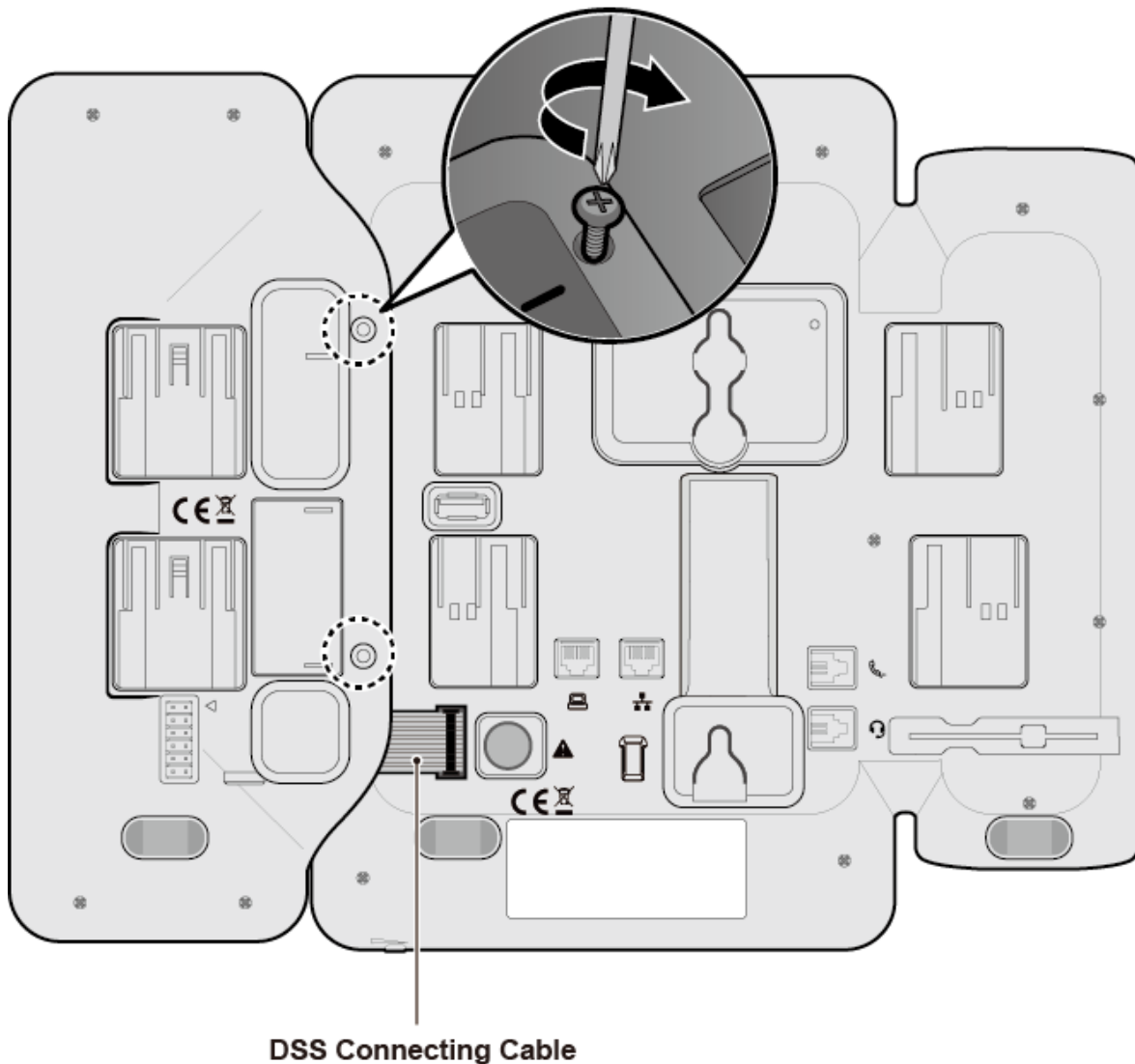

Figure 1.7-4: 1024idss Installation

1.8 Wall Mount Installation

The following instructions describe the wall mount installation. Note the foot-stand must not be installed.

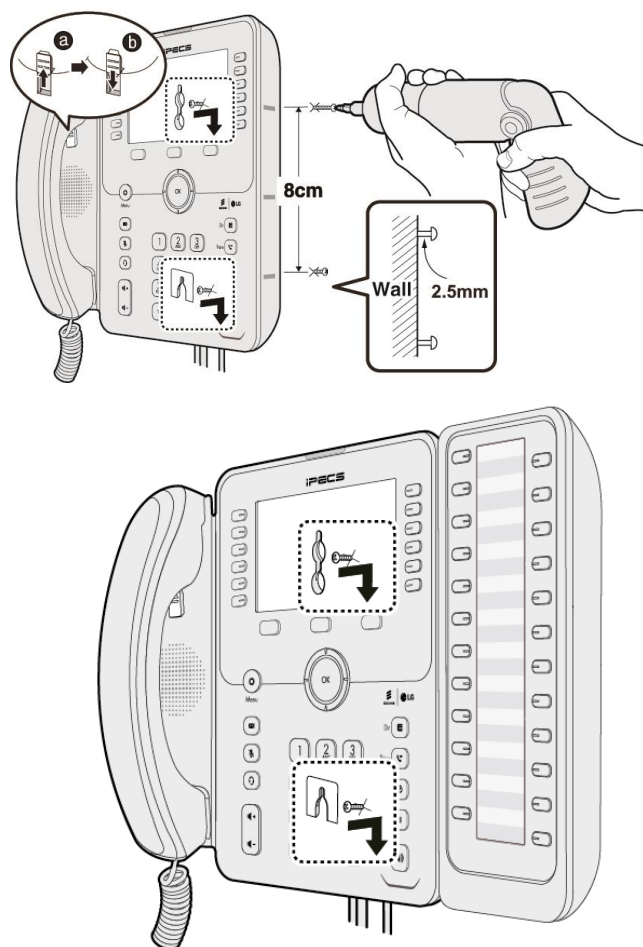

Figure 1.8_Wall Mount Installation

- 1) If installed, remove the foot-stand from the Phone and DSS.
- 2) Connect all wiring to the Phone as described in “1.6 1000i Installation” section. Connect the Phone side wiring only.
- 3) If required, install DSS as described in “1.7 DSS Overview & Installation” section.
- 4) Mark and drill two 7mm holes for plastic wall anchors (not included).
- 5) Insert the two anchors into the holes and insert and tighten the two screws (not included) leaving about 2.5 mm (1/8-inch) exposed.
- 6) Align the key holes in the phone over the screws and slide the phone down assuring the phone is secure.
- 7) Remove, reverse and re-install the handset hook so that the hook catches the groove in the handset receiver.
- 8) Hang the handset up on the handset hook.
- 9) Complete all wiring connections as described in “1.6 1000i Installation” section.

NOTE:

It may be necessary to remove the phone and tighten or loosen the screws for a secure mounting.

1.9 EHS Adaptor

Electronic Hook Switch (EHS) Adaptor is a device which electronically connects a EHS Base Set and Ericsson-LG Enterprise phone.

This EHS Adaptor enables remote control with the compatible EHS Base Set and the 1000i Series (except 1010i).

Compatible EHS Base Set Model List

Below are the recommended EHS Base Set models for your phone. For further information on installation see the EHS Adaptor Quick Installation Guide which is packed with it.

- **Jabra (IQ Protocol):** PRO P20, PRO 925, PRO 9450
- **Plantronics (PSB Protocol):** Savi W720, Savi W740-M, CS540
- **Sennheiser (DHSG Protocol):** D10, DW Pro

NOTE

Ericsson-LG Enterprise cannot guarantee other model except the above list and this list will be updated if we have finished testing the new one anytime.

1.10 Wi-Fi dongle

The 1040i and 1050i have a USB port so you can connect to a wireless network using a Wi-Fi dongle and provides LCD or Web menu for Wi-Fi setting.

The Wi-Fi setting menu is only displayed when the Wi-Fi dongle is installed, so you must first plug the dongle into the USB port on the back of the phone. In the LCD menu, setting is possible even if there is only an AP that can be connected.

All network and server settings except “Wi-Fi Settings” related to Wi-Fi connection use the wired network settings together. For detailed “Wi-Fi settings”, Please scan the below QR code or refer to the “[1000i IPKTS Wi-Fi Setting Guide](#)” document.

Also you can download it from global partner portal. If you have no authority to access global partner portal, then please contact to your local supplier.



1000i Wi-Fi Setting Guide

Supported models and version

- 1040i and 1050i (Version R1.2.0 or later)

Compatible Wi-Fi dongle Lists

- **TP-LINK Archer T3U** (AC1300 Mini Wireless MU-MIMO USB Adapter, Ver:1.0)
- **TP-LINK Archer T4U** (AC1300 Wireless Dual Band USB Adapter, Ver:3.0)
- **D-Link DWA-182** (Wireless AC1300 MU-MIMO Wi-Fi USB Adapter, Revision D)

NOTE

Ericsson-LG Enterprise cannot guarantee other model except the above list and this list will be updated if we have finished testing the new one anytime.

The Wi-Fi and Bluetooth dongle cannot be used together; only one must be connected to the USB port.

1.11 Entering Text

1.11.1 Phone Entering Text

Several features available to your phone require text entry. Station and Speed dial name assignment, and Intercom Text Messaging all require character entry.

Characters are entered by pressing the dial pad digit with the character multiple times based on the character position on the button.

For example; The letter 'C' is the third letter on the digit '2' thus, to enter a 'C', the dial pad digit '2' would be pressed 3 times.

If you want to enter the 'C' consecutively, wait a second to be moved the cursor to the right side of 'C' or press the right key of the navigation if it has navigation keys.

You can enter upper or lower case letters, symbols, or numeric characters. The entry mode is controlled with the Transfer(PGM) button.

The entry mode is indicated in the LCD of your phone as A, a, * or 1.

- The DND button deletes the last character. Or you may use the DELETE Softkey.
- The TRANSFER (PGM) button changes the input mode (A, a, * or 1) or you may use the MODE Softkey to change modes.

The chart below maps each dial pad digit to the corresponding character, symbol, and numeric entry.

NOTE

1000i series phone's Character Entry Chart (D1: 1st Digit, D2: 2nd Digit, D3: 3rd Digit, D4: 4th Digit)

Table 1.11.1: Phone Entering Text

Dial Pad Digit	Entry Mode			
	Upper Case <input type="text" value="A"/>	Lower Case <input type="text" value="a"/>	Symbols <input type="text" value="*"/>	Numeric <input type="text" value="1"/>
	Button Depressions			
	D1, D2, D3, D4	D1, D2, D3, D4	D1, D2, D3, D4	D1
1	@ : /	@ : /	@ : /	1
2	A B C	a b c	\$ %	2
3	D E F	d e f	^ & _	3
4	G H I	g h i	() ?	4
5	J K L	j k l	- + /	5
6	M N O	M n o	< > =	6
7	P Q R S	p q r s	; :	7
8	T U V	t u v	' " `	8

9	W X Y Z	w x y z	{ }	9
0	. , ? !	.,? !	., ? !	0
*	. *	. *	. *	*
#	Space (' ')	Space (' ')	# []	

1.11.2 System Entering Text

Below is a table when entering texts using the System Function.

NOTE

1000i series System's Character Entry Chart. (D1: 1st Digit, D2: 2nd Digit) This Table is available from unified s/w version 4.0.x

Table 1.11.2-1: System Entering Text Type 1

Char	D1	D2	Char	D1	D2	Char	D1	D2
A	2	1	T	8	1	1	1	0
B	2	2	U	8	2	2	2	0
C	2	3	V	8	3	3	3	0
D	3	1	W	9	1	4	4	0
E	3	2	X	9	2	5	5	0
F	3	3	Y	9	3	6	6	0
G	4	1	Z	9	4	7	7	0
H	4	2	Q	1	1	8	8	0
I	4	3	Z	1	2	9	9	0
J	5	1	.	1	3	0	0	0
K	5	2	SPC	*	1			
L	5	3	:	*	2			
M	6	1	,	*	3			
N	6	2	(#	1			
O	6	3)	#	2			
P	7	1	-	#	3			
Q	7	2	*	0	*			
R	7	3						
S	7	4						

Table 1.11.2-2: System Entering Text Type 2

Char	D1	D2	Char	D1	D2	Char	D1	D2
A	2	1	T	8	1	1	1	0
B	2	2	U	8	2	2	2	0
C	2	3	V	8	3	3	3	0
D	3	1	W	9	1	4	4	0
E	3	2	X	9	2	5	5	0
F	3	3	Y	9	3	6	6	0
G	4	1	Z	9	#	7	7	0
H	4	2	Q	1	1	8	8	0

Char	D1	D2	Char	D1	D2	Char	D1	D2
I	4	3	Z	1	2	9	9	0
J	5	1	.	1	3	0	0	0
K	5	2	SPC	*	1			
L	5	3	:	*	2			
M	6	1	,	*	3			
N	6	2	(#	1			
O	6	3)	#	2			
P	7	1	-	#	3			
Q	7	*	*	0	*			
R	7	2						
S	7	3						

1.12 Bluetooth dongle

The 1040i and 1050i have a USB port, so you can connect to a Bluetooth headset using a BT dongle, providing an LCD menu for Bluetooth settings.

The LCD menu is only shown when a Bluetooth dongle is installed, so you must first plug the dongle into the USB port on the back of the phone.

Adding/deleting/managing Bluetooth headsets is possible only with the phone menu without a system setting, but headset mode must be set in the system menu to use Bluetooth.

To be able to answer an incoming ring with a button on the headset, the Bluetooth headset always operates the ring regardless of the headset ring mode.

Because the 1000i only supports the Bluetooth headset profile (HSP), you can only (1) answer an incoming ring or (2) end a call with the button on the headset.

For detailed “Bluetooth settings”, Please scan the below QR code or refer to the [“1000i IPKTS Bluetooth Setting Guide”](#) document. Also you can download it from global partner portal. If you have no authority to access global partner portal, then please contact to your local supplier.



1000i Bluetooth Setting Guide

Supported models and version

- 1040i and 1050i (Version R1.3.1 or later)

Compatible Lists

- **Bluetooth USB Adapters:** Only Bluetooth 4.0 adapters with CSR chipsets are compatible.
 - ASUS USB-BT400 USB Adapter (Bluetooth 4.0 USB Adapter)
 - TP-LINK UB400 (Bluetooth 4.0)
 - UGREEN USB Bluetooth 4.0 Adapter (Chip model: CSR8510)
- **Bluetooth Headsets**
 - Plantronics PLT E100 Series
 - Jabra STEEL a1.17.0
 - Jabra Evolve 75e

NOTE

Ericsson-LG Enterprise cannot guarantee other models except the above list, and this list will be updated if we have finished testing the new one.

The Bluetooth and Wi-Fi dongle cannot be used together. only one must be connected to the USB port.

2 Using the LCD & Speakerphone

2.1 Using the LCD

Each 1000i model has a different display. The top line of each display shows various icons as shown in the Icons chart below.

The 1010i and 1020i have a 4-line display. The top section, which consists of a single line, displays the station number, various icons and time.

The 1020i has flexible button page number. The middle section displays the label for each flexible button. The fourth line displays the interactive softkey menu to guide you through feature access and User Program selections. The display indicates the function for each softkey based on the status of your phone. In some cases, there may be more than three available softkey functions. In this case, a right arrow displays on the right side of the menu line. The right Navigation key scrolls to the next set of three functions, and the left key moves to the previous menu choices.

The 1030i, 1040i and 1050i have a 5-line, 6-line and 8-line Liquid Crystal Display (LCD), respectively. The top section, which consists of a single line, displays the station number, various icons, time and flexible button page number. The middle section displays the label for each flexible button or a monthly calendar displays by the OK key. This section of the display also provides the called or calling name or number display, feature status, etc. The lower section, which consists of a single line, is the interactive menu of three softkeys described in the previous paragraph.

The 1030i, 1040i and 1050i have a screen saver function. The screen saver has two kind modes, Clock or LCD-Off. If not used, the screen saver will be activated after 10 minutes. This value or mode can be changed on the web manager or LCD menu.

2.1.1 1000i Series Phone Displays

Below is a figure of Display layout of each 1000i phone.

1010i Phone Display

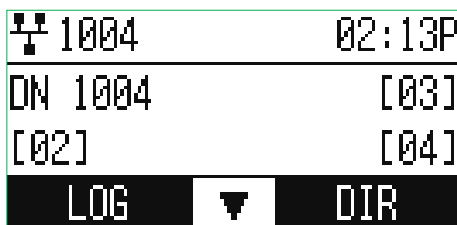

1020i Phone Display



1030i Phone Display



1040i Phone Display



1050i Phone Display

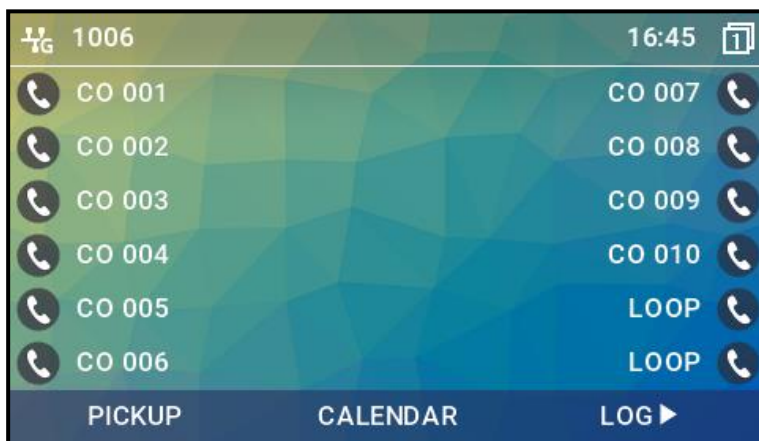

2.1.2 Upper line and Flexible button icons

2.1.2.1 Upper line Icons

Below is a chart list of each icons and their meaning.

Table 2.1.2-1: 1010i, 1020i Icons Description













Icon	Description
	The MUTE icon indicates the microphone is On and Off. (1010i only)
	The Headset icon indicates headset state, when shown the headset is active. (1010i only)
	The Wake-Up icon indicates one or more alarms are saved.
	LAN icon indicates the status of the LAN connection to the IP Phone. If the network speed is connected to Gigabit, the Giga-Icon () will be displayed. (1020i only)
	Missed call icon, indicates one or more missed calls.
	Call icon indicates call information during a call.
	The SRTP icon indicates SRTP call.
	EHS icon is displayed when EHSA is installed. If there is an error between EHSA and EHS headset, it will be changed to the EHS OFF icon () (1020i only).
	This icon is used to move another softkey menu.
	This icon is used to select or save the current menu.

Table 2.1.2-2: 1030i, 1040i, 1050i Icons Description









Icon	Description
	LAN icon indicates the status of the LAN connection to the IP Phone. If the network speed is connected with Gigabit, the Giga-Icon () will be displayed.
	Missed call icon, indicates one or more missed calls.
	Call icon indicates call information during a call.
	The SRTP icon indicates SRTP call.
	Wake Up icon indicates one or more alarms are saved.
	EHS icon is displayed when EHSA is installed. If there is an error between EHSA and EHS headset, it will be changed to the EHS OFF icon ().

Table 2.1.2-3: 1040i, 1050i Wi-Fi Icons Description

















Icon	Description
	The wireless connection status and signal strength are displayed on the top bar of the screen. (Very Poor[] / Poor / Fair / Good / Excellent[])
	Indicates that the wireless is disconnected when using a wireless connection.
	It is displayed when the Secured AP is displayed in the list.
	Appears when already Saved APs are displayed in the list.
	Appears when the currently connected AP is displayed in the list.
	Indicates the Signal Strength of APs shown in the list.
	Indicates the wireless band of the APs shown in the list. ( : 2.4G only,  :5G only,  : 2.4G/5G Both)









Table 2.1.2-4: 1040i, 1050i Bluetooth Icons Description

Icon	Description
	Indicates that Bluetooth is enabled, but no headset is connected.
	Indicates that the Bluetooth headset is connected and available.
	Appears when already Saved BT headset are displayed in the list.
	Appears when the currently connected BT headset is displayed in the list.

2.1.2.2 Flexible button icons (1030i, 1040i, 1050i)

Below is a chart list of each icons and their meaning.

Table 2.1.2-5: 1030i, 1040i, 1050i Flexible button icons Description

Icon	Description
	Not Assigned
	Station / Outside line button
	Feature or function button
	On-Line Presence of UCS Client
	Off-Line Presence of UCS Client
	Away Presence of UCS Client
	Busy Presence of UCS Client
	DND Presence of UCS Client

2.2 Using the Speakerphone

Activate the iPECS Speakerphone at any time (except for Paging) in place of lifting the handset to receive or place calls.

Additionally, you may switch between the handset and Speakerphone during a call. By keeping the handset Off-hook, the Group Listen feature is activated, which provides incoming audio over the speaker with outgoing audio from the handset. This permits a local 'group' to listen to both sides of the conversation without interfering with the conversation.

While in a conversation using the Speakerphone, Mute the microphone using the MUTE button. When Mute is active, the MUTE button LED will be illuminated. To turn off Mute, press the MUTE button again.

With Auto Speaker Select, activating or accessing a feature, or placing a call by pressing a flexible button will activate the Speakerphone automatically.

When using a Headset, the SPEAKER button controls the ON/OFF-hook state for the phone.

To use the Speakerphone to answer or place a call

Press the SPEAKER button, the phone goes off-hook and sends audio to the speaker and from the microphone.

To control the volume of the Speakerphone or handset

During a call, press the VOLUME + or – button.

To mute the microphone: (Speakerphone or handset)

During a call, press the MUTE button.

To turn off Mute (turn the microphone ON)

Press the MUTE button. Mute LED will be turn off.

To activate Group Listen while on an active handset call

- 1) Press the SPEAKER button.
- 2) Replace the handset on the Station.

3 Receiving Calls

3.1 Answering a Call While Idle

There are three basic types of incoming calls; internal/external ringing calls, Intercom Voice Announce calls, and Hold recalls.

Your phone may be assigned Ringing Line Preference; in this case, calls that ring are answered by lifting the handset. Otherwise, you must press the flashing flexible button. External calls to an iPECS Phone will appear under the outside line or line group button. For external calls, Delay Ring may be assigned allowing others to answer the call before the call rings at your phone.

Calls can be forwarded to your phone from another user. If providing call coverage for other users, you may also receive Station Call Coverage calls.

Calls placed on Hold, including Transfers, parked calls, etc. will recall if left on hold for too long.

ICM Voice Announce calls are answered based on the ICM Signaling mode at the receiving phone; in Hands-free (HF) mode, after the splash tone and announcement, speak normally into the microphone. In the Privacy (PV) mode, lift the handset to respond. You can assign the ICM Signaling mode as discussed in User Program Codes.

The LCD will display the calling number or, if available, the name of the station or outside line, CO Line Name Display.

To answer a call ringing at your phone:

Lift the handset or press the flashing flexible button (as needed), the call will be connected.

To respond to an Intercom Voice Announce call:

In HF mode, simply speak as normal into the microphone.

In PV mode, lift the handset to respond.

3.2 Responding to a Call While Busy

While you are busy on another call, you may receive a Muted Ring, Camp-On tone, or Voice-Over announcement. Muted Ring is provided over the speaker of your Phone indicating a Call Waiting. You also may receive Camp On tones, a burst of tones on top of the existing call, as an indication of another call waiting.

While busy, certain stations can activate Voice-Over to your phone. In this case, audio is received from both the active call and the Voice Over announcement at the same time.

Respond to any of these Off-hook Signals in one of several ways; place the existing call on Hold and answer the new incoming call, activate One-time DND, send a Silent Text Message, or ignore the new call.

Silent Text Message requires the phone be assigned a TEXT MESSAGE button to be sent the text message to the calling party. You may assign this feature to the flexible buttons on your iPECS Phone.

The Attendant or Secretary may use Intrusion to announce a call while you are busy.

3.3 Using Answering Machine Emulation (AME)

When your phone is allowed AME, your calls are connected to your voice mail directly, and, like a normal Answering Machine, the caller's voice is played over your speaker as it is recorded in the mailbox. Thus, you can screen the call before answering. There are two methods of notification and call screening provided, Ring or Speaker mode.

- **Ring mode** — In the Ring mode, the AME flexible button will flash to notify you of a call. You may press the flexible button to hear the caller as the voice message is recorded.
- **Speaker mode** — In the Speaker mode, the caller's voice is broadcast over the speaker of your iPECS Phone automatically.

Your iPECS Phone must be assigned with an AME Flex button for proper operation. AME is supported only on iPECS Phones.

To screen a call in Ring mode:

Press the flashing AME button, the caller's voice is broadcast over the station speaker and stored in the voice mailbox. In the Speaker mode, broadcast is automatic.

To stop the voice broadcast and leave the caller in Voice Mail:

Press the illuminated Speaker button.

To talk with the caller and record the conversation in Voice Mail:

Press the MUTE button.

To answer the call and cancel the voice message recording:

Press the illuminated AME button, the caller is connected, and the Voice Mail disconnected.

3.4 Differential Ring Signals

When multiple phones in a small area ring, it can be difficult to tell which are ringing. The iPECS Phone has 16 Ring Tones available for differentiating one phone's ringing from another. This feature can also be used to differentiate internal and external callers. Of the 16 tones, 4 are downloaded from the system and the remaining 12 are stored in the phone's memory.

After downloading the tone from the system memory, it can be selected as the Differential Ring Tone.

To download a Ring Tone from the System:

- 1) Press the Transfer (PGM) button and Dial 1 for Ring Tones.
- 2) Dial 5 for Ring Tone download.
- 3) Dial the phone's memory location to receive the tone (5-8).
- 4) Dial 0-9 for the desired tone number; the selected tone is heard.
- 5) Press the HOLD(SAVE) button to download the tone to your phone.

To select a Ring Tone from phone memory:

- 1) Press the Transfer (PGM) button and Dial 1 for Ring Tones.
- 2) Dial 1 for internal call ring or 2 for External call ring.
- 3) Dial 1-16 for the desired tone; the selected tone is heard.
- 4) Press the HOLD(SAVE) button to complete the selection.

3.5 Answering Calls at Night

In the Night mode, Loud Bell Control may be used to send ring signals to external bells. You may answer these calls with Universal Night Answer (UNA). iPECS Phones may be assigned a Flex button as a UNA button.

To answer a call ringing during night mode:

- 1) Lift the handset.
- 2) Dial *567 (UNA code). The code may be different based on your system's numbering plan. Please consult with your System Administrator for further information.

3.6 Answering Calls to Other Stations

When nearby stations are ringing, you may pick-up (answer) the call. You may answer a call ringing at a specific station (Directed Call Pick-Up) or answer the oldest call ringing at a station in your station group (Group Call Pick-Up). You may assign a flexible button with the Group Call Pick-Up code for one-touch access.

NOTE

Pick-Up will not answer calls on the ringing station's Private Line unless the line appears on your phone.

To answer a call ringing at another station:

- 1) Lift the handset.
- 2) Dial the Directed Call Pick-Up code *77. The code may be different based on your system's numbering plan. Please consult with your System Administrator for further information.
- 3) Dial the Intercom Number of the ringing station; the call will be connected.

To answer a call ringing at a station in your group:

- 1) Lift the handset.
- 2) Dial **, the Group Call Pick-Up code, the call is connected. The code may be different based on your system's numbering plan. Please consult with your System Administrator for further information.

3.7 Using Do-Not-Disturb (DND) to Block Incoming Calls

Activate Do-Not-Disturb when you wish not to be interrupted; the phone will block incoming calls. Your phone's display will show the DND status and calls route to the location configured in the system, generally your voice mail. Activate Do-Not-Disturb while ringing (One-Time DND); ringing terminates and the call is routed based on the system configuration.

When an Executive activates DND, calls forward to the defined Secretary automatically.

The Attendants and Secretary may be able to activate DND Override and intrude on an active call. The Attendants may also cancel DND at other stations.

To toggle DND ON and OFF:

Press the DND button.

3.8 Forwarding Calls

3.8.1 Forwarding calls to another Station or Voice Mail

Incoming calls may be diverted to other resources of the system. Resources include other stations, the built-in Voice Mail and External Voice Mail. Your LCD and the LCD of the 1000i phone receiving the call indicate the forward status.

Call Forward can be activated from your phone or from a different station (Call Forward, Remote). You may define the conditions or 'type of forward' as below:

- **Remote** – permits you to activate call forward from another station in the system. In this case, your station authorization code must be entered.
- **Unconditional** - all calls to the station, except recalls, will forward.
- **Busy** - Immediately forwards calls, except recalls, when the station is busy.
- **No Answer** - forwards calls to the station, except recalls, when the station is idle and does not answer within the No Answer timer.
- **Busy/No Answer** - forwards calls to the station if not answered within the No Answer timer.
- **Incoming CO Off-Net** – the attendant can forward calls on an outside line to a Speed Dial number. This setting is allowed by the Attendant station only.

NOTE

Calls to your Private Line forward to another station only if the receiving station has an appearance of the Private Line.

To activate Call Forward from your phone:

- 1) Lift the handset and Press the FORWARD Softkey or the DND button.
- 2) Dial the type of forward code 1-4.
- 3) Dial the destination number.

To deactivate Call Forward from your phone:

- 1) Lift the handset and Press the FORWARD Softkey or the DND button.
- 2) Press the # button on the dial pad.

To activate Call Forward from a different phone within the System (Call Forward, Remote):

- 1) Lift the handset and Press the FORWARD Softkey or the DND button.
- 2) Dial 0, the Remote Call Forward code.
- 3) Dial your Authorization code (Station number & Password). If you do not know your Password, contact your System Administrator.
- 4) Dial the 'type of forward' code 1-4.
- 5) Dial the destination number.

To deactivate Call Forward, Remote:

- 1) Lift the handset and Press the FORWARD Softkey or the DND button.
- 2) Dial 0, the Remote Call Forward code.
- 3) Dial your Authorization code (Station number & Password).
- 4) Press the # button.

3.8.2 Forwarding callers to a Text Message

Using an iPECS Phone, you can send a 'Text Message' to internal callers. When calling your Station, internal callers will automatically receive the selected message or you can select a message in response to an internal call, Silent Text Message.

There are 11 Custom Display Messages each up to 24 characters. Ten can be assigned by the Attendant and one assigned by you. In addition, there are ten fix Pre-Defined Text Messages; some allow auxiliary input for time, date, etc. as shown in list below.

- **Message 00:** your custom message
- **Message 01:** LUNCH RETURN AT hh:mm
- **Message 02:** ON VACATION AT DATE mm:dd
- **Message 03:** OUT OF OFFICE RETURN AT TIME hh:mm
- **Message 04:** OUT OF OFFICE RETURN AT DATE mm:dd
- **Message 05:** OUT OF OFFICE RETURN UNKNOWN
- **Message 06:** CALL (enter up to 17 digits)
- **Message 07:** IN OFFICE STA xxxx
- **Message 08:** IN MEETING RETURN AT TIME hh:mm
- **Message 09:** AT HOME
- **Message 10:** AT BRANCH OFFICE
- **Message 11 to 20:** Attendant (system) custom messages

To activate Text Message Forward:

- 1) Press the Transfer (PGM) button.
- 2) Dial the User Program feature code 51. (for UCP/eMG)
- 3) Dial the two-digit text Message code (00-20).
- 4) Dial any auxiliary input for messages 01-04 and 06-08.
- 5) Press the HOLD(SAVE) button, you will receive confirmation tone.

To cancel Text Message Forward:

- 1) In idle state, press FORWARD Softkey by pressing the Navigation right key.
or Lift the handset and press the DND button.
- 2) Press the # dial pad button.

To program your Station Custom Message (00) at your station:

- 1) Press the Transfer (PGM) button.
- 2) Dial User Program feature code 52.
- 3) Enter the message contents; up to 24 characters can be entered. Refer to section "1.11.1 Phone Entering Text" for details.
- 4) Press HOLD(SAVE) button to save the message.

4 Placing Calls

4.1 Internal Calls

You can place calls to other stations in the system over the Intercom. The call will ring, or for an ICM Voice Announce call, a splash tone will be heard.

Ring or Voice Announce is normally determined by settings at the called station but you may change this by dialing '#' after placing the call. By changing the mode, a Voice Announce call will ring or a ringing ICM call will allow Voice Announce (toggle).

You can assign a flexible button for Direct Station Selection/Busy Lamp Field (DSS/BLF). The DSS/BLF button allows you to call another station with the single touch of a button. The button LED will display the other station's status (ON=busy, OFF=idle).

When you go off-hook, you may connect to another station or system resource automatically. This Prime Line Preference may be immediate or delayed, allowing you to take other actions during the delay. Otherwise, you may press another flexible button before going off-hook to override Prime Line Preference.

If you go off-hook and take no action, Intercom dial-tone will time-out, and after the Howler tone is received, your phone will be placed out-of-service in Intercom Lock-Out; you then must hang-up to return the phone to an idle state.

To place an Intercom call:

- 1) Lift the handset.
- 2) Dial the Intercom number of the desired station.
- 3) When the call is answered or Splash tone is heard, begin speaking with the called party.

4.1.1 Using Camp-On when calling a busy station

If the called party is busy, you may activate Camp-On, Callback or, if allowed, Voice Over to the station.

You may also use Step Call; If the called party is busy, you are in same station group such as 1010~1019, dial the next station by dialing the last digit of the Intercom number (ex., 1019, press '9').

If you are the Attendant or Secretary, you may activate Intrusion.

- **Camp-On** allows you to wait off-hook for the called station to answer.
- **Callback** allows you to hang-up, and when the busy station returns to an idle state, the system will call your Station; after you answer the callback, the system will call the previously busy station.
- **Voice Over** allows you to make an announcement to the busy user by combining your voice with the other party connected to the busy user.

To Camp-On (wait off-hook) for a busy station:

Press * and await answer.

To request a Callback (wait on-hook) for a busy station:

Press the MSG button and hang-up.

To make a Voice Over announcement to a busy station:

- 1) Dial #.
- 2) After the Splash tone is heard, begin speaking.

4.1.2 Leaving a Message Wait Indication

If the called user does not answer or is in DND mode, you may leave a Message Wait indication. The called user will receive a Message Wait indication; the message icon will be displayed.

To activate Message Waiting:

When calling a station that is busy or in DND mode, Press the MSG button and hang-up.

4.1.3 Leaving a Voice Mail

If the called user does not answer, you may leave a Voice message in the user's mailbox. The called user will receive a Message Wait indication; the message icon will be displayed on the LCD screen.

To Leave a Voice Mail Message Waiting:

- 1) When calling a station that does not respond, press the MSG button.
- 2) Wait the user's mailbox greeting.
- 3) At the tone, leave your voice message and hang-up.

4.2 External Calls

4.2.1 Placing external (Outside Line) calls

External calls are placed on outside lines. These 'lines' are accessed either using a button on the iPECS Phone assigned as an outside line or using dial codes. Outside lines are grouped for different types of calls, local, long distance, etc. Using the line group code, you will be able to access any line from the group.

A flexible button on the iPECS Phone assigned as a LOOP button lets you access a line from a group. Refer to section "**10.2 Assigning Features to Flexible Buttons**" for details about assigning a CO Group Access Code button.

Dial codes for access to outside lines are:

- Individual outside line access: 88 + Line number
- Outside Line Group access: 8 + Group number
- Any outside Line access: 9

When dialing on a line that uses pulse style signals, you may activate Dial Pulse to Tone Switchover changing to DTMF dialing by using the '*' button, the signaling changes to DTMF. This will allow you to use baking services, etc. The default setting value is DTMF. This feature available on outside lines configured with Pulse dialing only.

When placing a point-to-point IP call, you must dial an IP address using the '**' button as the dot.

If Least Cost Routing is set-up, the number you dial will be analyzed and the system will place the call on the least expensive route.

You may be assigned dialing and/or outside Line Access Restrictions, in which case you will receive error tone if you attempt to dial or access a restricted number or outside line.

Line and Station Class of Service (COS), which establish dialing restrictions, may vary during Day and Night operation (Day/Night COS).

You may need to enter an Authorization code before placing calls, in which case you will receive a second dial tone. Please consult with your System Administrator for further information. Your external calls may be subject to Call Time Restrictions, you will receive a Call Warning Tone prior to disconnect.

NOTE

In the event of an emergency, assigned Emergency numbers (ex., a 911 call) may be dialed from any station in the System, regardless of a Station's dialing restrictions (COS).

To place an external call:

- 1) Lift the handset.
- 2) Dial the outside line or group number.
- 3) Dial the desired number.

4.2.2 Waiting for the next available Outside line

If all the lines connected to your system are busy, you will receive an All lines Busy signal. You may request to be notified when a line is available for use.

To join a queue if the selected/dialed line is busy:

- 1) Select the desired outside line button; when the busy notification is returned, press the MSG button.
- 2) Return to an idle state by going on-hook. When the line is available, your Station will be notified (ringing).

4.2.3 Account Codes: Tracking External calls for billing

In some cases, you or your company may desire to track calls for billing or other purposes. You may enter an Account Code, which is output from the system in the SMDR (Station Message Detail Recording) report. You may have an Account Code flexible button, which allows one-touch entry of an Account Code. Please consult with your System Administrator for further information.

Refer to **"10.2 Assigning Features to Flexible Buttons"** for details about assigning an Account Code button.

To enter an Account Code before the call:

- 1) Lift the handset.
- 2) Press the assigned ACCOUNT CODE button.
- 3) Dial the Account Code (1-12 digits).
- 4) Press *, Intercom dial tone is heard.
- 5) Place the outside call as normal.

To enter an Account Code during a call:

- 1) Press the assigned ACCOUNT CODE button.
- 2) Dial the Account Code (1-12 digits).
- 3) Press *.

4.2.4 Disable dialing from your phone

You can temporarily 'Lock' your phone by activating Temporary COS; the phone is not allowed to place outside calling, except emergency calls. To deactivate Temporary COS you must enter your Authorization code.

To activate Temporary COS:

- 1) Press the Transfer (PGM) button.
- 2) Dial 21 (User Program code for UCP/eMG). '21' is the Code that activates the Temp COS (Class of Service).
- 3) Press the HOLD(SAVE) button.

To deactivate Temporary COS:

- 1) Press the Transfer (PGM) button.
- 2) Dial 22 (User Program code for UCP/eMG). '21' is the Code that deactivates the Temp COS (Class of Service).
- 3) Dial your Authorization code (station number and password).
- 4) Press the HOLD(SAVE) button.

4.2.5 Temporarily override dialing restrictions at a phone

Override the dialing restrictions at any phone by activating Walking COS. When active, Walking COS applies the Class of Service of your Authorization for a call. Note that you must activate Walking COS for each call you make.

To activate Walking COS:

- 1) Press the Transfer (PGM) button.
- 2) Dial 23 (User Program code for UCP/eMG). '23' is the Code that deactivates the Walking COS (Class of Service).
- 3) Dial your Authorization Code (station number and password).
- 4) Place call as normal.

4.3 Directory

4.3.1 Directory button and Search

You may search a person's name by using the Directory button. The search result is applied to all directories. That means, if a user search name [Juliet], then the name is searched in all directory – System Directory, Personal Directory, Internal Station List and LDAP(if LDAP is available status).

To search a name via the Directory button:

- 1) Press the Directory button.
- 2) Enter the desired name for searching.
 - When LDAP is serviced in system, minimum searching characters are 2 letters.
 - When LDAP is not connected in system, minimum searching character is 1 letter.
- 3) Press Search soft button or ok button.
- 4) Matched name is displayed on LCD and the matched names can be scrolled by using the navigation key or the volume button.
- 5) To display the number of the searched name, Press Detail soft button.

4.3.2 Using System Speed Dial (System Directory)

The iPECS system has memory allocated for System Speed Dial numbers. These numbers may be divided into groups called System Speed Zone Groups. In this case, you may be allowed access to some numbers and not others and dialing restrictions may be invoked.

Only an Attendant or Administrator can access and modify System Speed Dial (System Directory).

To place a call using System Speed Dial:

- 1) Lift the handset and Press the SPEED button.
- 2) Dial the desired System Speed Dial bin(index) number.
- 3) System Speed Dial (System Directory) modification should be available through iPECS system Administrator.

4.3.3 Using Station Speed Dial (Personal Directory)

The iPECS system provides Station Speed Dial numbers; telephone numbers you commonly dial. The number of entries in this Private Directory may vary but is typically 100 accessed by bin numbers (000 – 099).

Contact your system Administrator for details. These numbers, which are entered at your station, may include several 'special' instructions.

Special instructions and the corresponding button are:

- **PAUSE** will insert a momentary pause in the dialing.
- **FLASH** as the 1st digit will activate dial tone detect.
- **FLASH** not as the 1st digit will generate a flash on the outside line.
- **MSG** as the 1st digit sends remaining digits in ISDN Keypad Facility messages.
- ****** as the 1st digit disables display of the stored number.
- ****** not as the 1st digit will send remaining digits as DTMF; converting Dial Pulses to the appropriate tones. Available on outside lines configured with Pulse dialing only.

When entering a Speed Dial, a 16-character name may be associated with the number for the Dial by Name directory. Refer to section “**9.2.1.1 Station Name Program**” for details on entering your name in the directory.

To place a call using Station Speed Dial:

- 1) Press the SPEED button and Dial the desired Station Speed Dial bin(index) number.

To enter a Station Speed Dial number with outside Line and Name:

- 1) Press the Transfer (PGM) button and Press the SPEED button.
- 2) Dial the desired Station Speed Dial number.
- 3) Select or dial the outside line or group number.
- 4) Dial the telephone number to be stored.
- 5) Press the HOLD(SAVE) button, or OK button.
- 6) Enter a name up to 20 characters, if desired. For details on character entries. Refer to section “**1.11.1 Phone Entering Text**” for details.
- 7) Press the HOLD(SAVE) button, or OK button.

To assign a Station Speed Dial directly to a flexible button:

- 1) Press the Transfer (PGM) button.
- 2) Press the desired flexible button.
- 3) Select the TEL NUM Softkey.
- 4) Select or dial the outside line or group.
- 5) Dial the desired number.
- 6) Press the HOLD(SAVE) button.
- 7) Enter a name for Dial-by-Name access. For details on character entries. Refer to section “**1.11.1 Phone Entering Text**” for details.
- 8) Press the HOLD(SAVE) button.

4.3.4 Using Dial by Name and Entering Your Name

Dial by Name may be employed in three different Directories - the Personal directory (Station Speed dial), System Directory (System Speed dial), and Internal Station List (Station Name).

NOTE

If other users want to call to you via the Internal Station List, you should register a name for your station (up to 20 characters).

To place a call using Dial by Name:

- 1) Press SPEED button and LIST button, or Press SPEED button twice.
- 2) Dial the desired directory.
 - 1: Personal Directory
 - 2: System Directory
 - 3: Internal Station
- 3) The LCD will display the names in alphabetical order.
- 4) Scroll using the Navigation up/down keys or enter search characters. Press the dial pad until the matched name displayed on the LCD screen. Refer to section “**1.11.2 System Entering Text**” to enter text from the dial pad for details.
- 5) Press the HOLD(SAVE) button to place the call.

To enter your station user name:

- 1) Press the Transfer (PGM) button.
- 2) Dial 74 the Station Name registration code, (for UCP/eMG). '74' is the Code that access the registration of the Station Name.
- 3) Enter the Name, up to 20 characters. Refer to section “1.11.1 Phone Entering Text” for details.
- 4) The name may also be configured under the Phone menu. Refer to section “9.2.1.1 Station Name Program” for details.

4.3.5 Using Redial List

The call logs are saved automatically in the system. Among the call logs, especially the latest dialed number is dialed as below way.

To dial the Last Number for the call log list:

Press the SPEED button and Dial *.

4.3.6 Using and Entering Saved Number Dial

You may store the last number dialed on an external call to the Saved Number Dial buffer for convenient dialing later. To use Saved Number Dial feature, you should store a number first. The Saved number is stored again if a new number is saved.

To place a call using Save Number Dial:

Press the SPEED button and Dial #.

To store a number in the Save Number Dial:

While on an outgoing external call, Press SPEED button twice.

4.3.7 Using Automatic Called Number Redial (ACNR)

When making an external call and a busy signal is received, Automatic Called Number Redial (ACNR) will retry the number until the call is connected, the feature is cancelled, or the maximum number of retries is attempted.

For each retry, the system will activate your speaker then place the call with the microphone muted. When the remote end answers, you must select the MUTE button, or lift the handset.

Either of these actions cancels the ACNR request as well as connects you to the remote party.

To set up ACNR, while on an outgoing call:

- 1) Use the Navigation button to display the next Softkey menu and select the ACNR Softkey.
- 2) Hang-up the handset.
- 3) The Station try to make a call using ANCR after few seconds later.

To cancel the ACNR request:

Press the ACNR STOP Softkey.

5 Call Handling

5.1 Call Transfer: Sending a call to a different destination

You can send an active call to another station or other resource of the system, Call Transfer. You can screen the transfer with the receiving party (Screened Call Transfer) or complete the transfer without screening (Unscreened Call Transfer).

Transferred calls, internal or external, are placed in Transfer Hold. These calls will receive Music on Hold (MOH) and will recall if not answered in a timely manner.

If an Unscreened Transfer encounters an error or DND, it may immediately recall at your Station. DSS/BLF buttons may be employed to transfer calls.

To Transfer an active call:

- 1) Press the Transfer (PGM) button.
- 2) Call the party to receive the transfer. Call the party by pressing the Station number to receive the call transfer.
 - Unscreened Call Transfer- Hang-up.
 - Screened Call Transfer– When your call is answered or Splash tone is heard, announce the call then hang-up.

5.2 Call Hold: Placing a call in a waiting state

You may place an active call in one of several holding states. In System Hold, other non-restricted stations may pick-up the call. In Exclusive Hold, only the holding station may pick-up the call.

The system is assigned a preferred hold type (System or Exclusive). You may override this Hold Preference by pressing the HOLD(SAVE) button twice.

The LEDs for outside line buttons flash at distinctive rates for the holding station and other iPECS Phone users.

There are also user operations such as pressing a DSS/BLF button that will place a call in Automatic Hold.

Calls will remain in the held state for a period then you will receive a recall. This Hold Recall is provided with a different ring signal. If not answered in a timely manner, the Attendant will receive Attendant Hold Recall.

To place a call on Hold:

Press the HOLD(SAVE) button.

5.3 Broker Call: Switching between two calls

You may switch between the active call and a call on Hold, placing the active call on Hold acting as a broker between two or more parties (Broker Call).

iPECS Phone users may 'broker' for multiple calls up to the number of outside line (Flexible Buttons) buttons on the phone. A flexible button on the iPECS Phone assigned as a U-LOOP button lets you access a line placing external (Outside Line) calls.

Refer to section “**10.2 Assigning Features to Flexible Buttons**” for details about assigning a U-LOOP button. Please consult with your System Administrator for further information.

To switch between two calls (Broker Call):

Press the desired outside line button. (in the Flexible button)

5.4 Joining Multiple People in a Conference

You can establish a Conference with up to 3 parties, or when your system is equipped with the Conference module, 32 parties can be joined in a conference. Check with your system administrator to determine if you have a Conference module. The other parties in the Conference may be internal or external.

A Conference can be placed on Hold and is subject to Hold Recall.

You may also use the Conference operation to join two external parties in a private conversation. This is an Unsupervised Conference, which is not subject to the normal Hold Recall operation.

To establish a Conference:

- 1) Establish call with one of the desired conference parties.
- 2) When called party answer the call, select the CONF Softkey.
- 3) Establish call with another conference party.
- 4) Select the CONF Softkey.
- 5) Repeat the above steps for additional parties.
- 6) Select the CONF Softkey again to establish the conference.

To place a Conference on Hold:

Press the HOLD(SAVE) button.

To retrieve the Conference from Hold:

Select the CONF Softkey.

To establish an Unsupervised Conference:

- 1) Establish conference with two external parties.
- 2) Select the CONF Softkey.
- 3) Hang-up the handset.

To retrieve an Unsupervised Conference:

- 1) Lift the handset.
- 2) Select the CONF Softkey.

5.4.1 Setting up a Conference Room

In addition to establishing an ad hoc Conference, up to 9 Conference Rooms can be set up, letting up to 32 parties converse when using a Conference module. When setting up a Conference Room, a password can be designated for invited parties (internal and external parties) to use for accessing the established Conference Room.

To set-up a Conference Room:

- 1) Press the Transfer (PGM) button.
- 2) Dial 53 to create a Conference Room, (for UCP/eMG). '53' is the Code that access the Active Conference Room.
- 3) Dial the desired Conference Room number (1-9).
- 4) To assign a password for the Conference Room, enter the password (up to 5 digits).
- 5) Press the HOLD(SAVE) button to establish the Room.

To join a Conference Room:

- 1) Lift the handset.
- 2) Dial *59, (Conference Room entry code for UCP/eMG). '*59' is the Code that access the Active Conference Room.
- 3) Dial the Conference Room Number (1-9).
- 4) Dial the Conference Room password.

To delete a Conference Room:

- 1) Press the Transfer (PGM) button.
- 2) Dial 54 (Conference Room delete code for UCP/eMG). '54' is the Code that deletes a Conference Room.
- 3) Dial the Conference Room number (1-9).
- 4) Dial the Conference Room password.
- 5) Press the HOLD(SAVE) button to delete the Conference Room.

5.5 Call Park: Placing a call on Hold to Page

You may transfer an active outside call to a special holding location (Park Orbit), which can be accessed easily from any station in the system. Typically, this feature is used with Paging to notify the desired user of a parked call.

Parked calls are subject to Hold Recall after the Call Park timer. Please consult with your System Administrator for further information.

To park an active external call:

- 1) Press the Transfer (PGM) button.
- 2) Dial the Park Orbit number. (eMG80: #601~#619 / eMG800 (UCP) #601~#800).
- 3) Return to idle.

To retrieve a parked call:

- 1) Lift the handset.
- 2) Dial the Park Orbit number.

5.6 Two-Way Record: Recording a call

You may record an active external conversation in your Voice Mail Box.

To activate Two-Way Record while on an outside call:

Use the Navigation button to display the next Softkey menu and select the RECORD Softkey, a record warning tone may be heard and recording starts.

To stop Two-Way Record:

Use the Navigation button to display the next menu of softkeys, and select the RECORD Softkey,
Or,

Hang-up the handset.

6 Send & Retrieve Messages

6.1 Responding to a Station Message Waiting Indication

Another station can leave a Station Message Waiting indication (MWI) to request a callback when you do not answer or your phone is in the DND mode. The message icon will display on your LCD screen. If programmed, a flashing MSG LED on the iPECS Phone also indicates when there is a Message Waiting. As a further notification, you may receive a periodic Message Wait Reminder Tone. You may review and delete messages as well as respond with a callback.

To review your Station messages:

- 1) Press the MSG button, the LCD shows the Message Summary display.

1. INTERNAL CALL BACK (002)	
2. MISSED CALL (000)	
3. VOICE MAIL (002)	
4. SMS (00)	
BACK	OK

- 2) Dial 1 (Internal Call Back List) to view message waits from other stations.
- 3) Press the navigation up/down button to scroll through your ICM messages.

To return a call from the list of ICM MWIs:

- 1) Press the navigation up/down buttons to scroll through the Intercom messages.
- 2) Press the OK Softkey (for 1010i / 1020i) or OK button to select and place the return call.

6.2 Getting Voice Mail Messages

When callers are sent to your Voice Mailbox, they can leave a voice message, in the built-in Voice Mail service, the iPECS Feature Server or an external Voice Mail system.

The Voice Mail system allows access to and management of received voice messages. While in your Mailbox, you may modify your password and Mailbox greeting. In addition, you can remotely control Call Forward for your station from the built-in Voice Mail.

You will require a valid Authorization code (password) for your Mailbox to access the Voice messages. Please consult with your System Administrator for further information.

To retrieve Voice Mail locally using a flexible button:

- 1) Press the programmed VOICE MAIL flexible button.
- 2) Dial your station number and corresponding password to receive the 'Number of Messages' prompt.
- 3) Follow the voice prompts to manage your messages.
- 4) At completion of your session, hang-up to return to idle.

To retrieve Voice Mail locally using the MSG button:

- 1) Press the MSG button, the LCD shows the Message Summary display.

1. INTERNAL CALL BACK (002)
2. MISSED CALL (000)
3. VOICE MAIL (002)
4. SMS (00)

BACK	OK
-------------	-----------

- 2) Dial 3 Voice Mail (VSF MSG).
- 3) After the prompt enter your station number and password.
- 4) Follow the voice prompts to manage your messages.
- 5) At completion of your session, hang-up to return to idle.

To access your Voice Mail Box from a Remote Location:

- 1) Call the telephone number of the outside line assigned for answer by the Auto Attendant.
- 2) At answer, dial # to receive the 'Station & Password' prompt.
- 3) Dial your station number and password to receive the 'Number of Messages' prompt.
- 4) Follow the voice prompts to manage your messages.
- 5) At completion of your session, hang-up.

6.3 Sending and Receiving Short Text Messages

You can exchange short text messages (up to 80 alphanumeric characters) with other iPECS display phone users. If you have short text messages, the message button will be flashing. If the ring/message LED is set to MWI, the ring/message LED will flash.

To send an SMS message to another iPECS display Phone: (for UCP/eMG)

- 1) Press the Transfer (PGM) button.
- 2) Dial 36, the SMS send code.
 - Dial 1 to resend an existing message.
 - Dial 2 to send a new message.
- 3) Enter the station range to receive the message, to send to a single station, enter the station number twice. (Example for single station: 1231,1231, for station range: 1231~1239)
- 4) Enter your message using the dial pad. Refer to “1.11.1 Phone Entering Text” for details on entering text.
- 5) Press the HOLD(SAVE) button to send your message.

To view your received Short text messages:

- 1) Press the MSG button, the LCD will display the Message Summary display.

1. INTERNAL CALL BACK (002)	
2. MISSED CALL (000)	
3. VOICE MAIL (002)	
4. SMS (00)	
BACK	OK

- 2) Dial 4 to view a received SMS; the first few SMS messages are shown in brief, press navigation key up/down to select the message. Newest Message will be listed end of the last.
- 3) Dial the Message number to view the entire SMS message.

To delete received Short text messages:

- 1) Press the DELETE Softkey or dial #.
- 2) Dial 1 to delete the message, 2 to cancel, or 3 to delete all received Short text messages.
- 3) Softkeys are provided for replying to a message.
- 4) The OK button will send a message, the right button is SMS Reply, and the left button moves up the menu.

7 Remote System Access

7.1 Mobile Phone Extension

When away from your desk or office you can place and receive iPECS calls on your mobile phone. You may need to activate the Mobile Phone Extension feature and register the Mobile Phone number.

To register a mobile phone number:

- 1) Press the Transfer (PGM) button.
- 2) Dial 37 (Register Mobile number code for UCP/eMG), '37' is the Code that access the Register Mobile Phone number.
- 3) Dial your mobile phone number.
- 4) Press the HOLD(SAVE) button.

To activate Mobile Phone Extension for your registered mobile phone:

- 1) Press the Transfer (PGM) button.
- 2) Dial 38 (Mobile Extension activation code for UCP/eMG), '37' is the Code that activate the Mobile Phone Extension feature.
- 3) Dial 1 to activate or 0 to deactivate.
- 4) Press the HOLD(SAVE) button.

To place a call from the mobile extension using the iPECS System:

- 1) Dial the DID phone number of your station; the system will check the Caller ID, answer the call and return intercom dial tone.
- 2) Place internal or external iPECS calls as normal.
- 3) Answer a call ringing at your mobile phone, the Station shows the "IN USE AT MOBILE EXT" on the LCD screen.

To Transfer a call from the mobile extension using the iPECS:

- 1) Dial "*" while on an iPECS call.
- 2) Dial the desired station, the call is transferred and the mobile phone returns to idle.
- 3) Reconnect to the transfer by dialing #.

NOTE

This feature is only available when the DID number is serviced by an ISDN or SIP outside line. Check with your system administrator to determine if the Mobile Extension feature is available to you.

8 Misc. Features

8.1 Call Log

In system web admin(Station Data – CLI Attributes), there is Call Log Usage option.

- Phone self: call log is controlled by each station.
- System serve: call log is controlled by system.

8.1.1 Call Log - Phone self option

You can view a log of incoming, outgoing and missed calls on the display (up to 100 records). 1000i phones provide a simple access to incoming (called), outgoing (dialed) and missed (lost) calls using a LOG Softkey.

NOTE

If a call is missed, the missed call icon will appear in the LCD. In this case, the LOG Softkey displays as LOG(M), indicating the missed call.

The call log menu and its appearances described in this chapter can be different with a real display when the system provides the call log menu and policy

To access the Call Log menu:

- 1) Press the LOG Softkey.
- 2) Use the Navigation up/down keys, to select a log menu (Called, Dialed, or Lost).

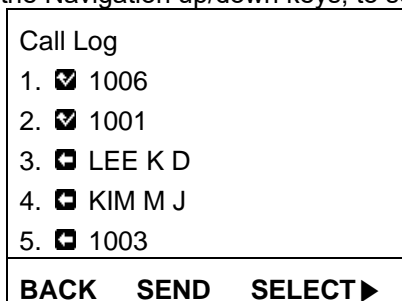

The icon in front of each log item indicates the type of call:

- ☒: Outgoing call (Dialed), ☒: Incoming call (Called), ☑: Missed call (Lost)

To place a call using numbers stored in the Call Log:

- 1) From the Call Log, use the Navigation up/down keys to select the log menu. (Called, Dialed, or Lost)

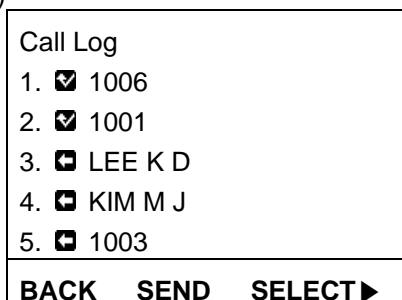

- 2) Highlight the desired item and press the OK or ✓ button to call the number. You may press the SEND or ✓ Softkey to call the number.

To save an external number to your Station Speed dial:

Use the Navigation up/down buttons to highlight the desired Call log item.

Press the HOLD(SAVE) button. You can save the number to a Speed Dial by pressing the SELECT Softkey then the SAVE Softkey.

Line Access Codes

The outside line access code in a log item is used to seize an outside line when placing an external call using the call log. Up to 5 line access codes can be saved.

Normally, the first line access code is the default outside line group code, typically '9', but, if the telephone number is the same as a Speed Dial number, the first line access code is the access code in the Speed Dial number. Therefore, the first line access code of each call log can be different but is not be editable.

You can assign Line access codes 2 - 5. You may select a code for use when placing external calls from the call log.

To select an access code:

- 1) From the Call Log, use the right Navigation key to advance to the next 3 Softkeys.

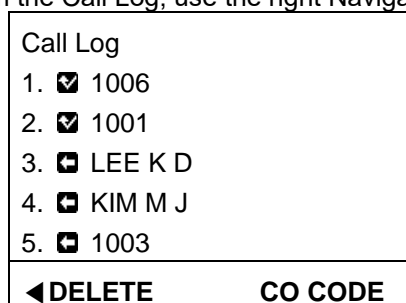

- 2) Press the CO CODE softkey. the code displayed with the '+' symbol is the current access code.

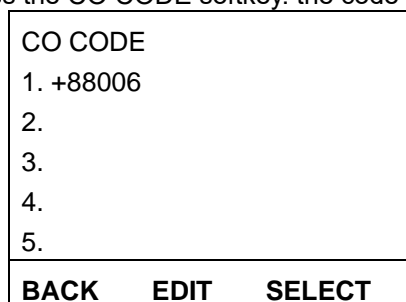

- 3) Use Navigation up/down buttons to highlight the desired item.
- 4) Press the SELECT Softkey.

To edit access codes 2-5:

- 1) From the Call Log, use the right Navigation key to advance to the next 3 Softkeys.
- 2) Press the CO CODE softkey. the code displayed with the '+' symbol is the current access code.
- 3) Use Navigation up/down buttons to highlight the desired code.
- 4) Press the EDIT Softkey to modify the selected code.

8.1.2 Call Log – System serve option

Using an iPECS Phone with 3-Soft buttons, you can view a log of incoming, outgoing and missed calls on the display. A Flex button must be assigned as a **{CALL LOG}** button, which allows easy access to the Call Log menu. The call log is displayed according to the following admin.

Call Log usage

Most Phones show the call log. But the way to display the call log is different between System Serve and Phone self. This option is to select which way to display the call log. The Call Log usage condition is as below:

- ✓ For color graphic phones, UCS client, and DECT phone: only 'Phone self' automatically regardless of this option.
- ✓ For other phone type except the above LIP and LDP phone: only 'System serve' automatically regardless of this option.

Call Log menu

This option select the call log menu for a call log type. The call log types have 4: Lost call, All call, Received call, and Dialed call.

If this option is ALL, display all calls. If this option is Type, display the call log 4 type and then select the desired type.

Answered By Group Member

One of the members can answer the call to the same ring group such as call coverage, linked pair, etc. At that time, the call log can set whether to leave the received call list or not by selecting Answered or Do-Not-Log.

But the call log is left in the received call list on the phone even though setting Do-Not-Log.

Internal Call Log

This option enables the call log to display 'Both (Incoming and Outgoing)' or 'Incoming only' or 'None'.

- **Both:** Incoming and outgoing call
- **Incoming only:** show Incoming call only
- **None:** Don't leave the internal call as call log

To assign a {CALL LOG} button

- [TRANS/PGM] + {FLEX} + [TRANS/PGM] + "57" + [HOLD/SAVE]

To access the Call Log menu

- 1) Press the **{CALL LOG}** button.

1. RECEIVED CALL
2. DIALED CALL
OK

- 2) Using the volume Up/Down keys, select the desired log (received, dialed, or lost).

123467890
24/07 14:51
BACK DELETE OK

The number of records in the Call Log is limited by the Call Log attribute in the System Data.

8.2 Contrast

The LCD brightness can be adjusted to enhance the display contrast.

To change the LCD Contrast:

While in an idle state, press the VOLUME + or - button to adjust the brightness (for UCP/eMG).

- +: increase (darker), -: decrease (brighter)

8.3 Background Music

While idle, your 1000i phone can play one of the 10 music sources available. The Background Music (BGM) is played over the speaker of your 1000i phone.

To turn on Background Music:

- 1) Press the TRANSFER/PGM button.
- 2) Dial '73', the BGM code. '73' is the Code that access the Background Music selection.
- 3) Dial the two-digit music source code (00 – 10). Code '00' is no BGM.
- 4) You may press the HOLD/SAVE button to play the audio or dial a different two-digit code (00 – 10) to select a different source.

8.4 Using Internal, External and Meet-Me Paging

You can broadcast announcements to other stations and/or external speakers. Stations are assigned to receive announcements from one or more of the Internal Page Zones. In addition, the system can send announcements to one or both of the External Page Zones that can be connected to external speakers. Your iPECS System permits access to the following types of Page Zones.

Note the number of Internal and External Zones varies between the iPECS systems based on the platform and size of the iPECS system. Contact your system administrator for details.

- **Internal Page Zones**
- **Internal All Call Page**
- **External Page Zones**
- **External All Call Page**
- **All Call Page**

If the desired Page Zone is busy, you can elect to be recalled when the zone returns to idle. When the zone returns to idle, you will receive a callback.

In your Page announcement, you can request a party answer the Page using Meet-Me Paging. In this case, the paged party may answer the page from any phone in the system by dialing the Meet-Me code. After dialing the Meet-Me code, the party is connected to your phone and the Page Zone returns to idle.

To make a page:

- 1) Lift the handset.
- 2) Dial the desired Page Zone, contact your system administrator for details.
- 3) If assigned, after the page warning tone, make your announcement.

To queue for a busy Page Zone:

- 1) Press the MSG button.
- 2) Replace the handset, returning to idle.

To answer a Meet-me-Page:

- 1) Lift the handset.
- 2) Dial Meet-Me-Page code. Please consult with your System Administrator for further information.

8.5 Push-To-Talk (PTT) Page

iPECS Phones can be assigned as a member of one or more of the system's nine Push-To-Talk (PTT) page groups. You login or log-out of any one or all PTT groups to which your phone is assigned. Once logged in, place or receive one-way page announcements to/from other users who are logged in to the same PTT group.

To log-in to a PTT group:

- 1) Dial #0.
- 2) Dial the desired PTT group number (1-9 or 0 for all groups).

To log-out of the PTT group(s):

- 1) Dial #0, the PTT Log-in/out code.
- 2) Press the * dial pad button.

To assign a PTT Flex button:

- 1) Press the Transfer (PGM) button.
- 2) Press the desired flexible button.
- 3) Press the Transfer (PGM) button.
- 4) Dial 99 (User Program code for UCP/eMG). '99' is the Code that assigns the Push-To-Talk (PTT) Page.
- 5) Press the HOLD(SAVE) button.

To place a page announcement to the active PTT group:

- 1) Press and hold the PTT flexible button.
- 2) After confirmation tone, make your page announcement.
- 3) When you finish your announcement, release the PTT flexible button.

8.6 Wake-Up Alarm

iPECS systems include an Alarm clock for each station in the system. You may have access to one or 5 alarm settings and may set the alarm as a one-time or repeating alarm. When you set an alarm, you select the repeating type (1 – 4) as below.

- 1 - Alarm activates one-time on the assigned date and time.
- 2 - Alarm repeats daily, Monday through Friday.
- 3 - Alarm repeats daily, Monday through Saturday.
- 4 - Alarm repeats daily each day of the week.

To set the Wake Up Alarm clock:

- 1) Press the Transfer (PGM) button.
- 2) Dial 41 (Alarm register code for UCP/eMG), '41' is the Code that set the Wake Up Alarm Time.
- 3) If requested, enter the Wake-up alarm index number, "1 to 5".
- 4) Dial the desired 2-digit hour (24-hour mode), then the 2-digit minute for alerting.
- 5) If requested, enter the Repeating type, "1" to "4".
- 6) If requested, enter the date for the alarm as two (2) digits for year, month and day of the month.
- 7) Press the HOLD(SAVE) button.

To erase a Wake-Up alarm:

- 1) Press the TRANSFER(PGM) button.
- 2) Dial "42". '42' is the Code that releases the Wake Up Alarm Time.
- 3) If requested, enter Wake-Up alarm index number, "1" to "5".
- 4) Press the HOLD(SAVE) button.

To stop the alarm notification

Lift the handset or press the Speaker button.

8.7 Alarm/Door Bell

The system can monitor up to four external contacts as Alarm or Door Bell contacts. The number of monitoring circuits varies based on the iPECS platform and size. Please consult with your System Administrator for further information.

- **Alarm Monitor**—should the external contact activate; a unique Alarm Ring signal and LCD display may be received. To restart the monitor circuit, the external contacts must be deactivated, and the Alarm Ring signal terminated.
- **Door Bell**—a unique Door Bell Ring, a single tone burst, may be received each time the external contact is activated. A system contact can be assigned to act as a Door Open contact. You can then activate the contact through dial codes, or a flexible button assigned with the Door Open code.

To terminate the Alarm signal:

Dial *565 (Alarm Stop code, for UCP/eMG). '*565 ' is the Code that stop the Alarm signal.

To activate the Door Open contacts:

- 1) Lift the handset.
- 2) Dial the Door Open code, #* and contact number 1-4.

8.8 System Voice Memo

The integrated Voice Mail of your iPECS system incorporates several Voice Memos to provide you with general information such as station number, date, time, and feature status. Voice Memos are heard over the iPECS Phone speaker.

For the Station Status Memo, the following items are reported:

- ICM Signaling Mode (Handsfree/Tone/Privacy)
- Station IP Address
- Station Mac Address
- Number of messages x (x: number of all messages waiting)
- Wake-Up Time (hh:mm)
- Do Not Disturb
- Forwarded to station xxx
- Forwarded to speed bin xxx
- Queued outside line xxx
- Locked (Temporary COS)
- COS x

To hear the Date & Time memo:

- 1) Dial the Voice Memo code (661 or *661 for UCP/eMG).
- 2) The Date and Time memo are heard, "The Date is May 2nd.Time is 12:57 pm".

To hear the Station Number Prompt:

- 1) Dial the Voice Memo code (662 or *662 for UCP/eMG).
- 2) The Station Number memo is heard, "This is station 150".

To hear the Station Status memo:

- 1) Dial the Voice Memo code (663 or *663 for UCP/eMG).
- 2) The Station Status Memo is heard.

NOTE

Only activated features are announced.

8.9 Hot Desk

iPECS phones in the system may be assigned for Hot Desk operation. These Hot Desk phones let you log-on and use the Hot Desk phone as if it were your station.

Once logged-on, the Hot Desk station will take on the attributes assigned to your station number, and you can make and receive calls as normal.

When you log-out of the Hot Desk, you can choose a forward destination, such as voice mail, for your calls. Contact your system administrator for details.

To Log on to a Hot Desk station:

- 1) Press the Transfer (PGM) button.
- 2) Dial *0 (Hot desk login code for UCP/eMG), '*0' is the Code that log on to the Hot Desk station.
- 3) Dial your Authorization Code (Hot desk Station Number and Password). Please consult with your System Administrator for further information.

To Log out of the Hot Desk station:

- 1) Press the Transfer (PGM) button.
- 2) Dial * twice (Hot desk logout code for UCP/eMG), '**' is the Code that log out from the Hot Desk station.
- 3) Use the VOLUME + or - button to select a call forward destination for your calls. You can select a speed dial, mobile phone, built-in Voice Mail, or an external Voice Mail group.
- 4) Press the HOLD(SAVE) button.

9 Display Menu

9.1 Menu Overview

The Display Menu permits access to the Phone settings and the Network Configuration for the phone. In addition, the menu includes alternative methods for handling Conference Rooms and Short Text Messages, and configuring the Flexible buttons on your phone. If you are the Attendant, access to special Attendant features are available through the menu.

Note that the BACK Softkey can be used to move back one menu step.

The 1010i / 1020i use the symbol (✓) softkey for OK button, and the Volume for Navigation.

9.2 Using the Menu

The Display Menu is activated using the Menu button. Use the Navigation keys to scroll the menu choices; items are selected using the OK button or softkey, or dialing the digit associated with the selection. The Menu includes the six sub-menus as shown below.

To activate the Display Menu:

Press the MENU button and Scroll the list with the Navigation or Volume up/down keys then select an item with the OK button or softkey or dial the menu digit.

- | |
|---|
| <ol style="list-style-type: none">1. PHONE SETTING2. CONFERENCE ROOM PGM3. ICM SMS4. NETWORK CONFIG5. BUTTON PROGRAM0. ATTENDANT |
|---|

NOTE)

The "0. Attendant" selection will only display on the System Attendant phone.

9.2.1 Phone Setting

The Phone Settings allow you to control several aspects of your phone as shown in the Phone Settings menu below.

To configure the Phone Settings:

Press the MENU button and select the Phone Setting sub-menu and then the following menu displays.

- | |
|---|
| <ol style="list-style-type: none">1. STATION NAME PROGRAM2. ICM RING3. CO RING4. PASSWORD PROGRAM5. LANGUAGE PROGRAM6. STA RING DOWNLOAD |
|---|

- 7. BACKLIGHT
- 8. FONT PROGRAM
- 9. LCD DIMMING

9.2.1.1 Station Name Program

After selection, enter the name for your phone using the dial pad. You can enter up to 20 characters. Refer to section “1.11.1 Phone Entering Text” for details on entering text. When done, press the OK button or Softkey.

9.2.1.2 ICM Ring/CO Ring

When multiple phones in a small area ring, which are ringing can be difficult to tell. The iPECS Phone has 16 Ring Tones available for differentiating one phone’s ringing from another. Different tones can also be assigned for internal and external ringing calls. Ring tones can also be established as described in “3.4 Differential Ring Signals”.

- Use the Navigation or Volume up/down keys to select ICM (internal) or CO (outside) ring tones and select with the OK button or Softkey.
- Use the Navigation or Volume up/down keys to scroll through the list of ring tones and select the tone with the OK button or Softkey. You may use the NEXT Softkey.

9.2.1.3 Password Program

For several features, you may need to enter an Authorization code or password. You can change the password as desired from 1 to 12 digits.

- Enter your current password and press the OK button or Softkey.
- Your Station number is the default password. Then enter the new password and press the OK button or Softkey to store the new password.

9.2.1.4 Language Program

The phone can display text in multiple languages.

- Use Navigation or Volume up/down keys to highlight available languages then press the OK button or Softkey to select the language.

9.2.1.5 Station Ring Download

The system stores 10 ring tones four of these tones can be stored in the phones memory. For more details, refer to “3.4 Differential Ring Signals”.

- Select the phone’s ring tone memory position, 5-8, use the dial pad to select the system tone to download then press the HOLD(SAVE) button or SAVE Softkey to download the tone.

9.2.1.6 Backlight

There are several selections for the illumination of the LCD backlight.

- Use Navigation or Volume up/down keys to highlight the backlight control and select with the OK button or Softkey.

9.2.2 Conference Room

You can create a Conference Room that others, internal and external can call to join a conference. An alternative procedure to creating and joining a Conference Room is provided in “5.4.1 Setting up a Conference Room”.

To configure a Conference Room:

- 1) Press the MENU button and select the Conference Room sub-menu.
- 2) The following menu displays.

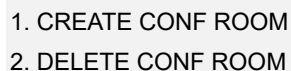

1. CREATE CONF ROOM
2. DELETE CONF ROOM

- 3) Press the Navigation or Volume up/down keys to highlight the desired option then press the OK button or Softkey or dial the option number.
- 4) Enter the room number (1-9) and dial a 5-digit password that will be required to enter the room.
- 5) Press the OK button or Softkey.

9.2.3 ICM SMS

You can send and receive short text messages, SMS messages, to and from other stations. For additional details and an alternative approach, refer to “6.3 Sending and Receiving Short Text Messages”.

To send an SMS message:

- 1) Press the MENU button and select the ICM SMS sub-menu.
- 2) The following menu displays.



1. SEND MESSAGE
2. IN BOX (03)

- 3) Use the Navigation or Volume up/down keys to highlight “SEND MESSAGE” then press the OK button or Softkey. You may dial the digit 1 to select the “SEND MESSAGE” item.
- 4) Dial 1 if resending, or 2 to send a new message (edit).
- 5) Enter the Station number or range to receive the message.
- 6) Write your message, for details refer to “1.11.1 Phone Entering Text”.
- 7) Press the OK button or Softkey to send the message.

To retrieve a SMS message:

- 1) Press the MENU button and select the ICM SMS sub-menu.
- 2) The following menu displays.



1. SEND MESSAGE
2. IN BOX (03)

- 3) Use the Navigation or Volume up/down keys to highlight “IN BOX” then press the OK button or Softkey You may dial ‘2’ to select the “IN BOX” item.
- 4) The display shows a line for each message. Highlight the desired message and press the OK button or Softkey to read the entire message.

9.2.4 Network Configuration

The network Configuration menu affects the connection of your phone to your local area network; it is intended for access by trained technicians only. The structure of the Network Configuration menu is shown below.

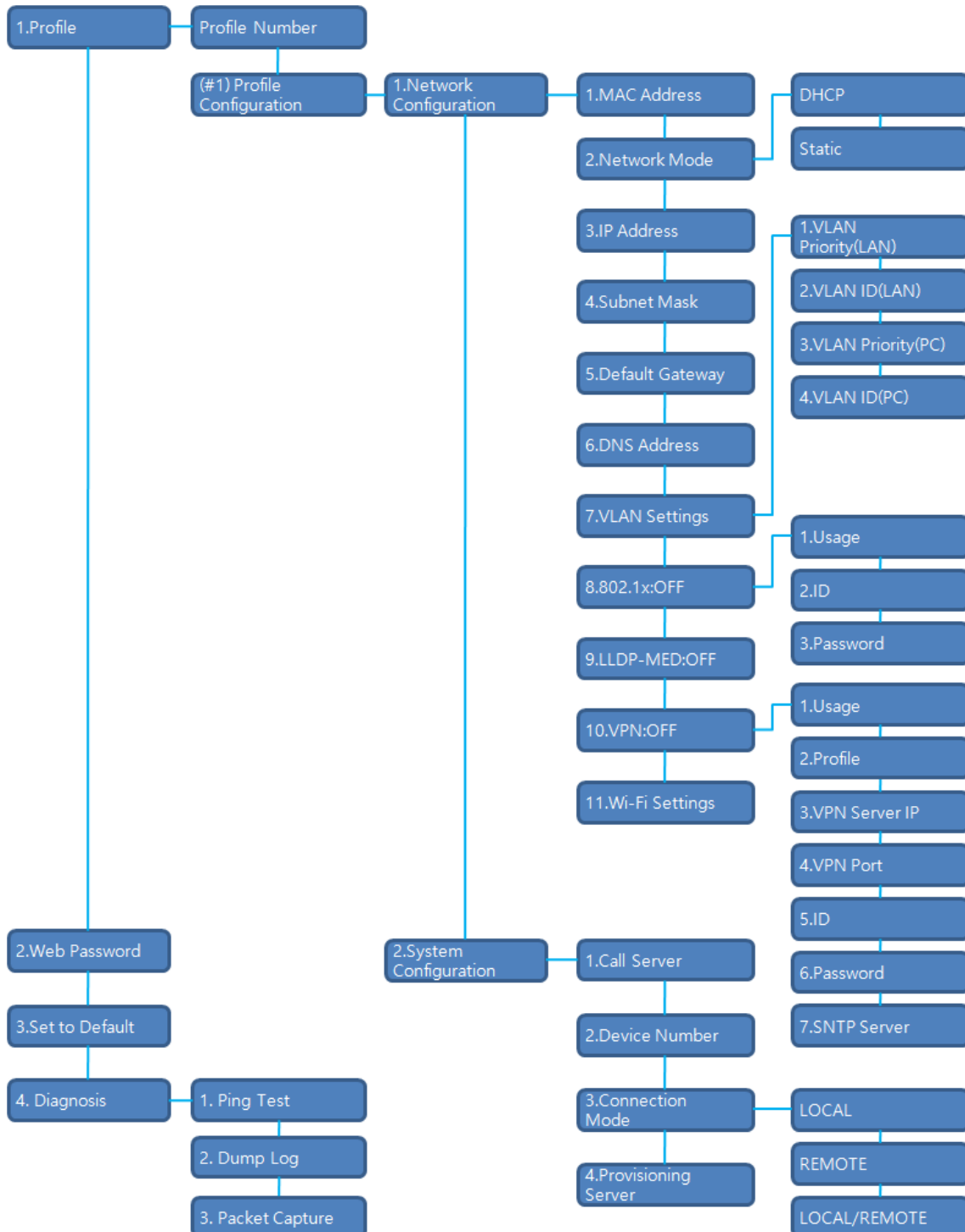
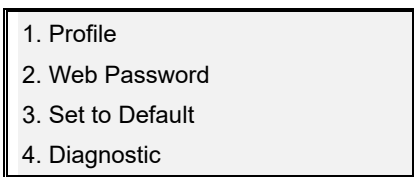

Figure 9.2.4: 1000i menu tree of network configuration

- **Profile:** 1000i phone operates two independent profiles. Each profile has submenus as shown above.
- **Web Password:** sets passwords for all accounts as default in both profiles.
- **Set to Default:** sets all features as default.
- **Diagnosis** - used in case of network emergency and to diagnose the terminal itself problem.

To access Network Config. settings:

- 1) Press the MENU button and select the Network Configuration sub-menu.
- 2) Enter the password; to display the sub-menu. (contact to your system administrator)



- 3) Use the Navigation or Volume up/down keys to highlight an item then select the item with the OK button or Softkey. You may dial the digit for the menu item to select item.
- 4) Enter the appropriate data for the item select then press the OK button or Softkey.

9.2.5 Button Program

You can save or change a feature to flexible button, and attach a label to the flexible button.

To configure a Button Program:

- 1) Press the MENU button and select the Button Program sub-menu.
- 2) The following menu displays.



- 3) Press the Navigation up/down keys to highlight "BUTTON FEATURE" then press the OK button or Softkey.
- 4) Select the desired flexible button, the current feature displays.
- 5) Enter or select the new feature.
- 6) Press the Navigation up/down keys to highlight "BUTTON LABEL" then press the OK button or Softkey, the current label is shown in the LCD.
- 7) Use the dial pad to enter a new label. Refer to section "Phone Entering Text" for details.
- 8) Press the OK button or Softkey.

9.2.6 Attendant menu

The Attendant menu is only available on the System Attendant phone.

To access the Attendant menu:

- 1) From the Attendant Station phone, press the MENU button.
- 2) Press 0 (Attendant); the following will display.

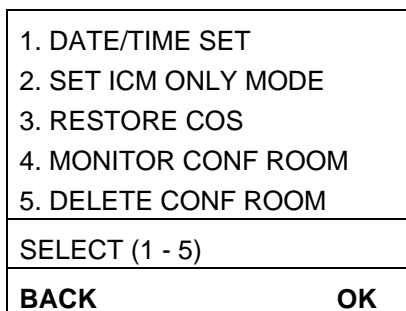

- **Date/Time Set**—Enter mm/dd/yy and press the OK button or press the HOLD(SAVE) button; enter hh/mm and press the OK button or press the HOLD(SAVE) button.
- **Set ICM Only Mode**—Dial the Station Range for ICM only calls (ex., 103-108=103108), press the OK button or press the HOLD(SAVE) button.
- **Restore COS**—Dial the Station Range to restore the COS (ex., 103-108=103108), and press the OK button or press the HOLD(SAVE) button.
- **Monitor Conference Room**—Enter the Conference Room number to view the number of attendees in the Conference Room.
- **Delete Conference Room**—Enter the Conference Room number and press the OK button or press the HOLD(SAVE) button to delete.

9.2.7 Additional phone configurations

You can see and change the configuration related to your IP phone, other than network settings. This is supported on 1030i, 1040i and 1050i only.

To set additional phone configurations:

- 1) Press the MENU button.
- 2) Select “6. PHONE CONFIG”.
- 3) Change the value of the desired menu.
- 4) Press the OK softkey or HOLD button to save.

To set the background image on IDLE screen:

- 1) Go to the additional settings menu.
- 2) Select “1. Background image”.

There are 2 or 3 pictures you can use. Press [Next] button to choose. IP phones basically provide 2 pictures for background image. You can add a third picture through the WEB manager. See the next section 11 Web Manager for details.

- 3) Press the OK softkey or HOLD button to save.

To set the label transparency on IDLE screen:

- 1) Go to the additional settings menu.
- 2) Select “2. Label Transparency”.
- 3) Enter a value to use as the transparency of the label background on IDLE screen. The closer to 100, the more transparent.
- 4) Press the OK softkey or HOLD button to save.

To set the date transparency on Calendar screen:

- 1) Go to the additional settings menu.
- 2) Select “3. Calendar Transparency”.
- 3) Enter a value to use as the transparency of the date background on Calendar screen. The closer to 100, the more transparent.
- 4) Press the OK softkey or HOLD button to save.

10 Features & Flexible Buttons

10.1 Entering Station Program Data

A special code set is available for iPECS Phone users to assign certain attributes such as Authorization Codes (Passwords). After entering the **User Program** mode, you dial the codes to select the attribute and setting. Once selected, the setting is saved.

A list of the User Program codes, the feature/function and inputs required are available from your system administrator.

In some cases, you can assign these codes to a flexible button.

To assign user programmable attributes to your station:

- 1) Press the Transfer (PGM) button.
- 2) Dial desired User Program codes. (Refer to “Appendix A: User Program Code”.)
- 3) Press the HOLD(SAVE) button.

10.2 Assigning Features to Flexible Buttons

You may assign features and functions to the flexible buttons on your iPECS Phone, and may be able to assign outside line buttons.

Flexible buttons may be assigned for most features providing One-Touch feature activation. For example, a flexible button may be assigned to access the Account Code feature and may include the Account code digits.

Features that may be assigned to a flexible button include.

- **DSS/BLF**—Enter station number.
- **Speed Dial**—Enter Station/System Speed dial bin.
- **Flex Numbering Plan**—Enter Flex Numbering Plan code (contact to your system administrator).
- **User Program Code**—Press the Transfer (PGM) and enter a User Program code (contact to your system administrator).
- **Outside Line**—Enter the line or group number.

To assign a feature to a Flex button:

- 1) Press the Transfer (PGM) button.
- 2) Press the desired flexible button.
 - In case of Station number, outside line or line group, enter the number then press the HOLD(SAVE) button.
 - In case of Flexible Numbering Plan Code, enter the numbering plan code then press the HOLD(SAVE) button.
 - In case of a User Program Code, press the Transfer (PGM) button and enter the Program Code then press the HOLD(SAVE) button.

10.3 Web Manager

The Web Manager is a web-based tool for configuring the IP Phone parameters. The Web Manager can access to parameters not available through the Network setting menu.

In addition to remote access to the IP Phone configuration, Web Manager is more convenient when configuring a number of IP Phones or parameters of a single IP Phone.

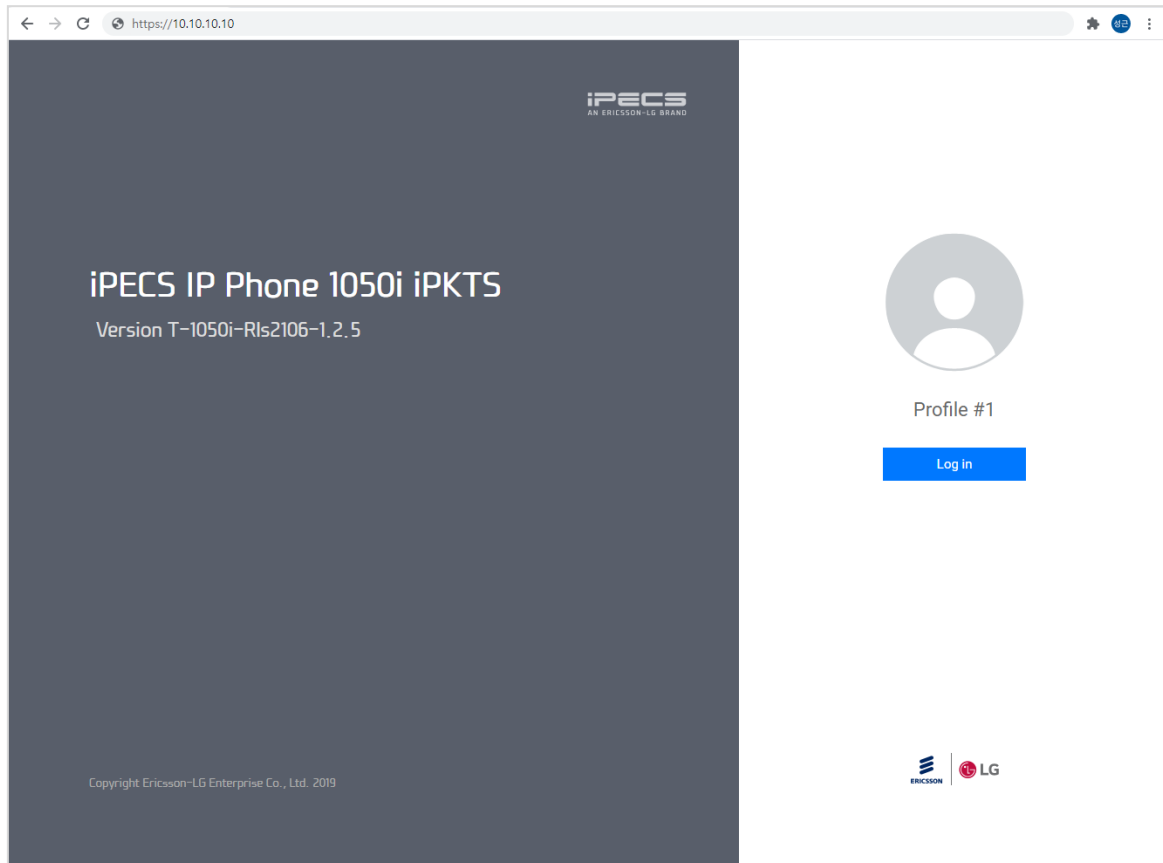

Figure 10.3-1: 1000i Web manager

To access Web manager:

- 1) Access the IP phone's IP address with a web browser. (ex, <https://10.10.10.10>)
- 2) Proceed by pressing "Proceed to ... (unsafe)" if no certificate is installed.
- 3) Confirm the profile number to access, and press Login button.
- 4) Enter a valid user name and password. The default user name is "admin" and the default password is "ipkts". If you try to access with the default account like this, you must change the password in the next step.
- 5) Enter a user name and new password once you change the default password.

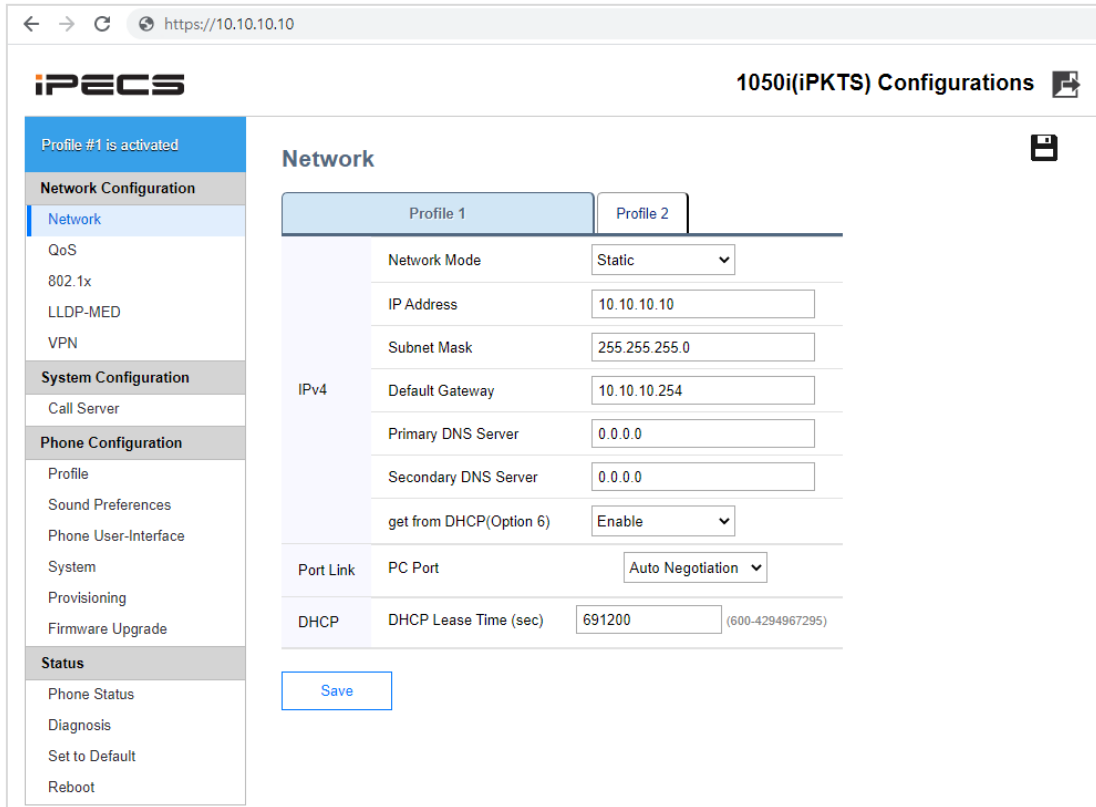

Figure 10.3-2: 1000i Web Configuration

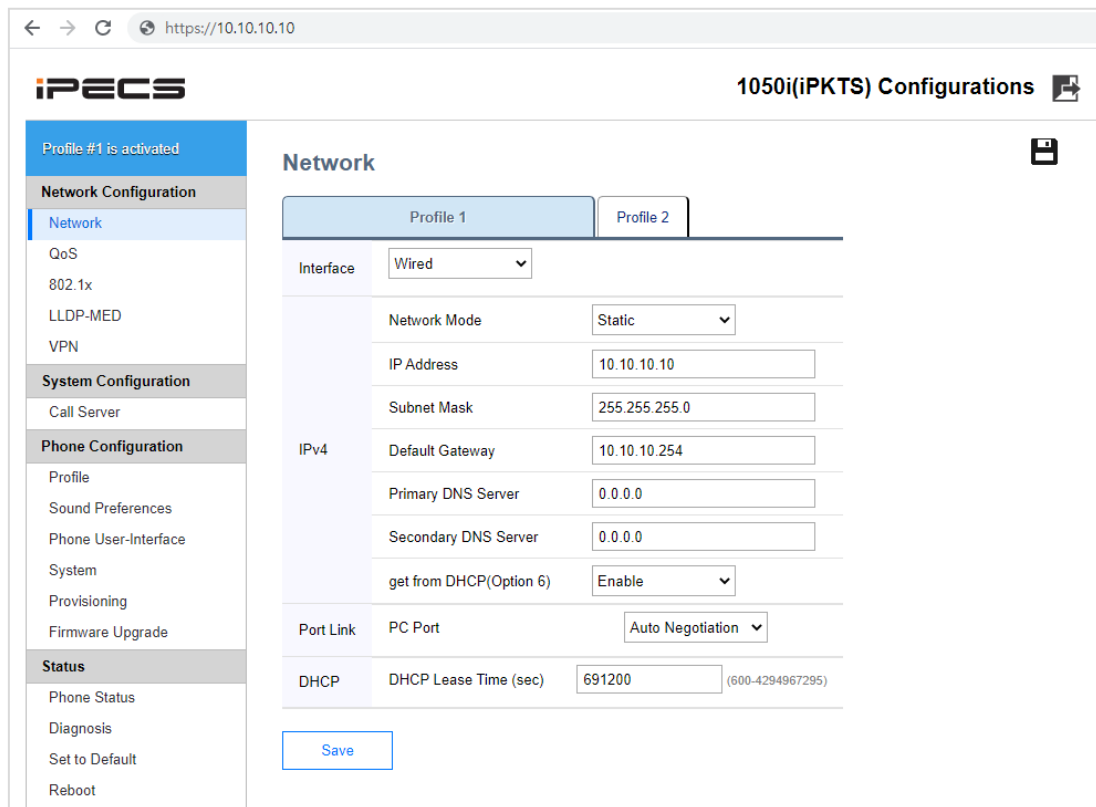
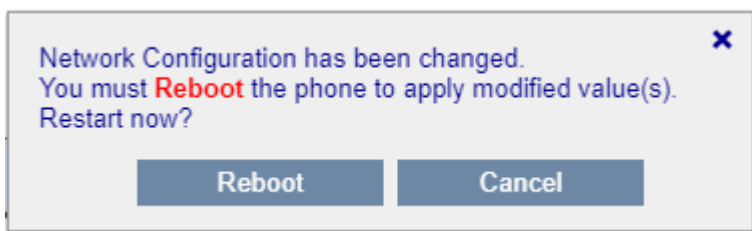

Figure 10.3-3: 1000i Web Configuration when a Wi-Fi dongle is inserted in the 1040i/1050i.

To set the network configurations:

- 1) Click one menu item in “Network Configuration” category on the left.
- 2) Check the contents of the selected menu in the right.
- 3) Change the value of the desired fields, then click the Save button or the Save icon at the top.
- 4) If you change a field requires a reboot, the following confirmation box is displayed.



You can click the ‘Cancel’ button to continue the setup process. Or you can click the ‘Reboot’ button to restart and apply the new value.

If you do not reboot after changing/saving settings, the following text will be displayed at the bottom left. In this case, a reboot is required for normal operation.

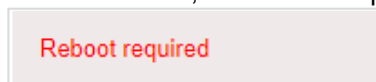

- 5) If you leave the page without saving, the following confirmation message appears. Click the "Cancel" button to stay on the current page to keep your changes or click "Leave" to exit the menu without saving your changes. The label of the button may vary depending on the browser.

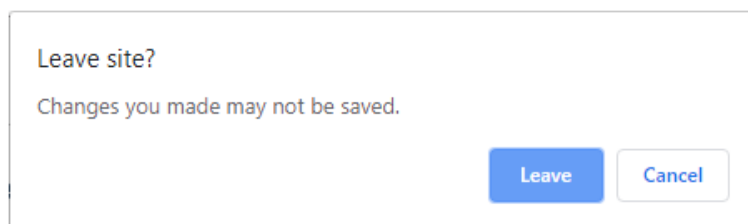

To set VPN configuration

- 1) Select VPN under Network Configuration. The currently active Profile Number is displayed in the Profile area at the top left, and Profile No. 1 is activated in the figure below.
- 2) To use VPN, change Activation to Enable, set Profile to Upload when you receive an OVPN file from the system administrator, and set Profile to Manual when you receive settings and certificate from system administrator.
- 3) If you select Manual profile, after entering all settings and click Save to save the values. And, upload the certificate received from the system administrator by clicking Upload button of VPN CA Certification.
- 4) If you select Upload Profile, upload the OVPN file received from the system administrator. If OpenVPN user ID/Password are required, enter the corresponding value.
- 5) For using OpenVPN, time synchronization is required for certificate verification, enter the SNTP server value for both Manual/Upload Profiles.
- 6) After uploading all necessary files and completing all settings, press the Reboot menu on the left to restart the phone and apply the new settings.

VPN

Profile 1
Profile 2

Activation Disable ▾

Profile Manual ▾

Server Address

Server Port (1-65535)

ID

Password

Hash Value sha1 ▾

Protocol UDP ▾

User Option

Verb (0-11)

SNTP Server

VPN Status Disabled

VPN CA Certification

Root CA Certificate is not installed.

Choose File
No file chosen

VPN

Profile 1
Profile 2

Activation Disable ▾

Profile Upload ▾

ID

Password

Verb (0-11)

SNTP Server

VPN Status Disabled

OVPN Configuration

OVPN configuration file is not installed.

Choose File
No file chosen

To set the Wi-Fi configurations: (1040i/1050i only)

If you change Interface to 'Wireless' in Figure 10.3-2b, the "Wi-Fi" menu is expanded as shown below. Conversely, if you select "Wired", it will disappear.

Network

Profile 1
Profile 2

Interface Wireless ▾

AP List None

SSID

Frequency Band

Security

Encryption

Wi-Fi

ID (802.1x)

Password (802.1x)

Key

MAC of AP

Link Speed

Signal Strength

Network Mode Static ▾

You can do the following in this menu, please refer to the "1000i IPKTS Wi-Fi Setting Guide"

To set the server configurations:

- 1) Click the “Call Server” link on the left.
- 2) Enter values in the Server Address, Phone Number fields.
- 3) Set the connection type among the three modes.
- 4) Save new changes.

To change the profile:

- 1) Click the “Profile” link on the left.
- 2) Check and change the value of Profile Number item on the top.
- 3) Click the Save button or the Save icon at the top.
- 4) The confirmation text that the profile number has changed is displayed in the upper left corner. It is not active yet, and changes to the profile are completed after the restart.

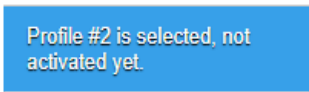

- 5) Reboot.

To set the phone user-interface configurations:

- 1) Click one menu item in the Phone Configuration category on the left.
- 2) In the Phone User-Interface screen, the following attributes may be changed.
 - Use of Lunar Calendar; When it is enabled in Korean mode, the lunar calendar is displayed on the LCD calendar. (Supported on 1030i, 1040i and 1050i)
 - Background Image; 1030i, 1040i and 1050i can use this menu to set the background image of LCD. In addition to specifying in default pictures, you can also add a new picture from your PC. The size of user background image should be 320x240 (1030i), 480x320 (1040i) and 480x272 (1050i). The supported image formats are png and bmp format. (24 bit per pixel format)
 - i. Press the [Set user background image] button.
 - ii. Check the optimal size of the picture.
 - iii. Select the appropriate picture and press the [Upload] button.
 - iv. Click the Save button or the Save icon at the top.
 - Label Transparency; The transparency of the label background on IDLE screen. The closer to 100, the more transparent. It's supported on 1030i, 1040i and 1050i.
 - Screen Timeout; One of the screensaver features. The screensaver is activated after the timeout has elapsed since the last action. It's supported on 1030i, 1040i and 1050i.
 - Screen Saver type; The screen to be shown during the screensaver operation. It's supported on 1030i, 1040i and 1050i.
 - LCD Password is required to access the Network Setting menu. Please contact your system administrator for more information, including defaults.
- 3) Change the value of the desired fields, then click the Save button or the Save icon at the top.

To upgrade firmware:

- 1) Prepare a valid firmware SW distributed by the manufacture.
- 2) Click “Firmware upgrade” in the Phone Configuration category on the left.
- 3) Click “Upload File” after choosing a new upgrade file. You cannot cancel the upgrade process after starting. Do not turn off the power while applying new firmware.

- 4) At the end of the process, the result of upgrade or a reboot button will appear. Restart completes applying new firmware.

To set as default:

- 1) Click the “Set to default” link on the left.
- 2) Or go to the “Phone Status” menu. Find “Load Default Settings” section and click the “OK” button in that section.
- 3) Confirm your actions. Restart completes the setup as default.

To control the LSS display:

1000i (except 1010i) can have up to 3 1048ilss. Once 1048ilss is attached, you can see the LSS control menu in the Phone configuration category of the web manager.

- 1) Check if the LSS is attached well.
- 2) Click “LSS (1048ilss)” menu in “Phone Configuration” category on the left.
- 3) In LSS (1048ilss) menu, the following attributes may be changed.

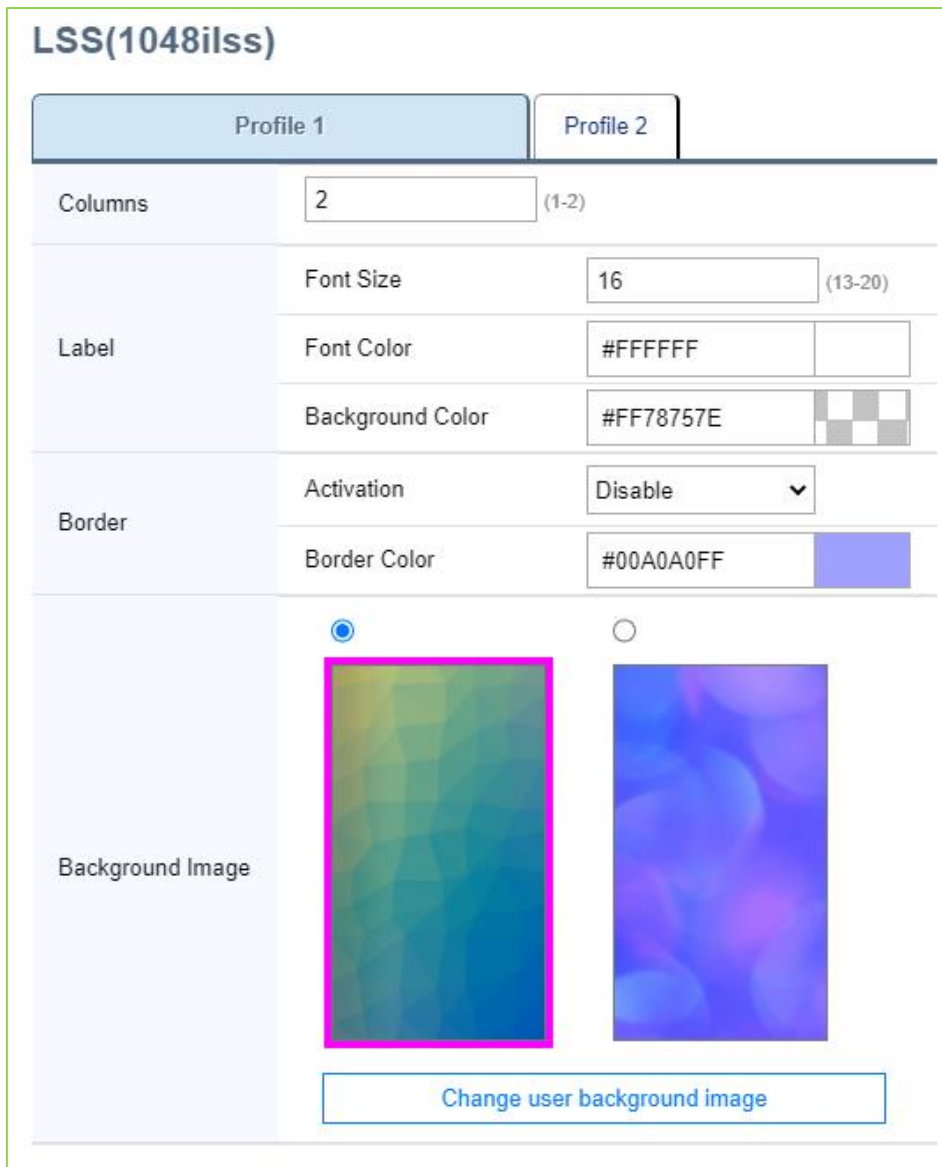

Figure 10.3-4: LSS menu

- Columns: The number of columns on the LSS screen. 1048ilss has two columns of 12 fixed buttons per one column. You can use only left 12 buttons by determining this 'Column number' as 1.
- Label – Font size: The font size of LSS display
- Label – Font color: The text color of LSS display expressed in Hex color code. To set it, enter the color value directly or use the color picker.
- Label – Background color: The background color of LSS display, expressed in combination of 'transparency' and 'Hex color code'. To set, click the color preview box to use the color picker.

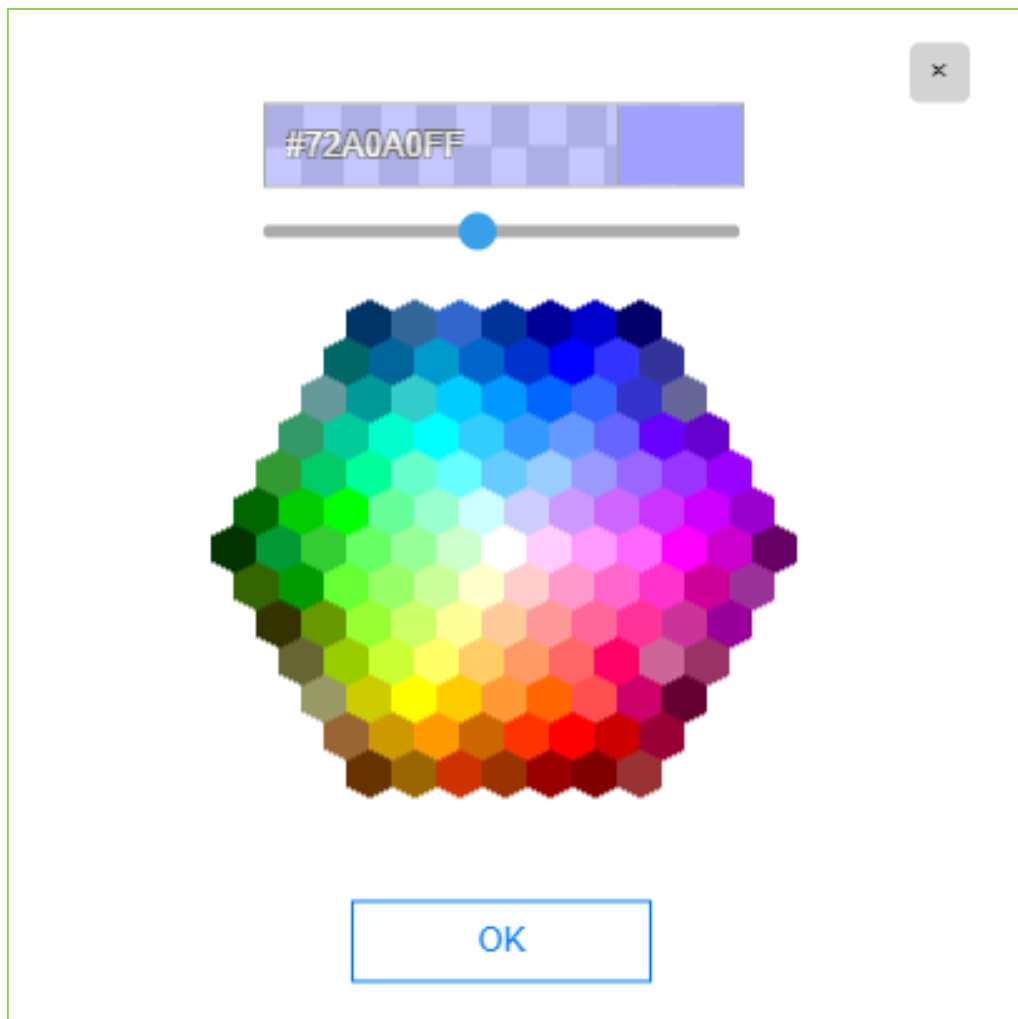

Figure 10.3-5: Color picker

- Border – Activation: Each label on LSS screen has a border. You can set this property to 'enable' to show it.
 - Border – Border color: The color of border, expressed in combination of 'transparency' and 'Hex color code'. To set, click the color preview box to use the color picker.
 - Background: 1048ilss has a color graphic background, using one of the suggestions. The size of user background image should be 272x480 in PNG or BMP format. To use a new picture on your PC, follows these steps:
 - A. Press the [Change user background image] button.
 - B. Check the optimal size of the picture.
 - C. Select the appropriate picture and press the [Upload] button.
- 4) Click the Save button or the Save icon at the top

To check the phone, some diagnosis tools are provided in the “Status” > “Diagnosis” menu.

Dump Log

Download

Packet Capture

Start

Port Mirroring

Start

LCD Capture

Save

Dump Log (Wi-Fi)

Start

Dump Log (Bluetooth)

Start

To dump a log

- 1) Press the “Download” button in the “Dump Log” section.
- 2) Wait for a while.
- 3) The log file is saved to the PC.

To dump a log (Wi-Fi): (1040i/1050i only)

This is shown when a Wi-Fi dongle is attached.

- 1) First, use “Start” and “Stop” to collect logs.
- 2) Press the “Download” button in the “Dump Log (Wi-Fi)” section.
- 3) Wait for a while.
- 4) The log file is saved to the PC.

To dump a log (Bluetooth): (1040i/1050i only)

This is shown when a Bluetooth dongle is attached.

- 1) First, use “Start” and “Stop” to collect logs.
- 2) Press the “Download” button in the “Dump Log (Bluetooth)” section.
- 3) Wait for a while.
- 4) The log file is saved to the PC.

To start capture the packets from/to the phone:

- 1) If you want to capture some specified packets, enter a filter string in the “Packet Capture” section.
- 2) Press the “Start” button.
- 3) The phone will start the capturing of packets.

To stop capture the packets and download:

- 1) Press the “Stop” button in the “Packet Capture” section.

- 2) Press the “Download” button.
- 3) Packet captured file is saved to the PC.
- 4) Press the “Delete” button to remove the temporary log file saved in the phone.

To start port mirroring from the LAN port to the PC port:

- 1) Press the “Start” button in the “Port Mirroring” section.
- 2) The PC connected to the PC port of the phone can capture the packets from/to the phone.

To stop the port mirroring:

Press the “Stop” button in the “Port Mirroring” section.

To capture a LCD screen:

- 1) Press the “Save” button in the “LCD Capture” section.
- 2) Captured image file is saved to the PC.

Appendix A: User Program Code

Extension User Program Code Table

The Extension User program menu is shown in the LCD of iPECS Multi-button phones to guide users in programming features and functions.

To use these codes, press the Transfer(PGM) key then enter the below code.

Table A: User Program Code Table

Code	Description
11X	Intercom Differential Ring
12X	CO Line Differential Ring
13	Intercom Answer Mode (1: HF/2: TONE/3: PV)
14X	Call Coverage Attribute Setting
15X	Station Ring Download
21	Knock Down Station COS
22	Restore Station COS
23	Walking COS
24	ICR Scenario
25	LIP Keypad Stat
26	Call Profile
30	VM Mobile Notify
31	Message Retrieve Method
32	Message Retrieve Example
33	User Authorization Code Registration
34	DID Call Wait
35	Message Wait in Executive/Secretary pair
36	Send SMS Message
37	Register Mobile Extension
38	Make Mobile Extension active
39	Register Mobile Extension CLI
41	Set Wake-Up Time
42	Wake-Up Time Disable
51XX	Custom/Pre-select Message Display (XX = 00-20)
52	Register Custom Message (Message 00)

Code	Description
53	Active Conference Room
54	De-active Conference Room
551	Monitor Conference Group
56	Multiple Mailbox Greeting
57	{Call Log Display} Button Assignment
61	Headset/Speakerphone Mode
62	Change Ring Mode
71	LCD Display Mode
72	Version Display
73	Background Music
74	Station User Name Registration
75	Display Phone IP Address
76	Change Phone IP Address
77	Display Phone MAC Address
78	Network Configuration
79	Display Phone Version
7#	Forced Release Button Assignment
7*	Display Serial number/Package for SMEMU
80	{Record} Button Assignment - With Voice Mail
81	{CLIR} Button Assignment
82	{COLR} Button Assignment
83	{ATD DND} button assignment
84	{Account Code} Button Assignment
85	{LOOP} Button Assignment
86	{ATD Intrusion} Button Assignment
87	{INTERCOM} Button Assignment
88	{Camp-on} Button Assignment
89	{Send Keypad Facility IE} Button Assignment
8#	{OHVO} Button Assignment
8*1	DID Restriction Button Assignment
8*2	DISA Restriction Button Assignment

Code	Description
8*3	Bomb Threat History Button Assignment
8*5	Headset Button Assignment
8*6XYZA	Toggle Ring Mode Button Assignment X,Y,Z,A: 1(Day), 2(Night), 3(Timed), 4(Auto)
90	{SPEED} Button Assignment
91	{CONFERENCE} button assignment
92	{CALLBACK} button assignment
93	{DND} button assignment
94	{FLASH} button assignment
95	{MUTE} button assignment
96	{MONITOR} button assignment
97	{REDIAL} button assignment
98	{CALL FORWARD} button assignment
99	{PTT} button assignment
9*XX	{In-Room Indication} button assignment (XX = 01-10)
*6XXX	Set Forced Fwd Dest (XXX: hunt group no.)
*7XXX	Forced FWD To Dest (XXX: hunt group no.)
*0	Hotdesk Login
**	Hotdesk Logout

Appendix B: 1000i Series Model Specification

Enjoy a wide selection of easy-to-use system IP phones to enrich your communications experience with a powerful speaker phone and wideband voice support.

1000i Series phones from Entry level to advanced terminals, designed to best fit the users' needs.

Table B: 1000i Series Models Specification

Specification		1010i	1020i	1030i	1040i	1050i
Display	LCD Size	2.4"	2.8"	2.8"	3.5"	4.3"
	LCD Resolution (Pixels)	132 x 64	132 x 64	320 x 240	480 x 320	480 x 272
	UI Line	4 Line	4 Line	6 Line(Max)	6 Line	8 Line
	Backlit	N/A	Yes			
	LCD Type	Black and White	Gray scale graphic	Color graphic		
Keypad	Programmable button with BLF	YES (4)	YES (8)	YES (6)	YES (8)	YES (12)
	Softkey	YES(3)				
	Navigation key	Yes				
	Fixed button (dedicated hard keys)	YES (11 buttons)	YES (11 buttons)	YES (11 buttons)	YES (11 buttons)	YES (11 buttons)
	LED Buttons	YES (1 Color LED)	YES (3 Color LED)			
Self labeling	4 buttons	4 buttons x 3 pages	6 buttons x 3 pages	8 buttons x 3 pages	12 buttons x 3 pages	
Paper labeling	-	4 buttons	-	-	-	
Total program-able keys	4	16	18	24	36	
Network interface	Ethernet (IEEE 802.3/1 Gigabit)	YES (2*10/100 Base-T)	YES (2*10/100/1000 Base-T)			
	EHSA Support	N/A	YES			
Wireless interface	USB dongle Support	NO			YES	
Speakerphone		YES (Full duplex)				

Specification		1010i	1020i	1030i	1040i	1050i
Audio interfaces	Handset (RJ-9)	YES				
	Headset(RJ-9)	YES				
	Headset(USB)	N/A			YES	
	Headset(BT)	N/A			YES(BT Dongle Support)	
IM Presence	N/A			YES		
BLF	YES					
Power	Local(Optional - 48V,0.3A)	YES				
	PoE (802.3af)	Class 2	Class 2	Class 2	Class 3	Class 3
Audio	Codec	G.711, G.729AB, G.722, Opus				
	Call Signaling Protocol	Ericsson-LG Enterprise iPECS protocol				
	Features	Echo cancellation, VAD, CNG, Hearing Aid Compatible				
Network	IP Address	Static / DHCP				
	LLDP-MED, VLAN	YES				
	QoS	Dynamic jitter buffering, 802.1p/Q, Layer 3 TOS, DiffServ				
Security	Standard	SRTP w/AES-128, 802.1x/EAP-MD5(EAPOL), Password login				
	VPN (Open VPN)	YES				
Management	Auto/Remote Upgrade	YES				
	Web Management	YES				
Others	Phone tilting	YES (2 Level Bracket)				
	DSS Support	N/A	YES(1024idss,1048ilss,1048idss)			
	Wall mount	YES				
	Ring type	Wave file/FM method				

Appendix C: Document abbreviations

Acronym and Abbreviation

For the purpose of this document, the following abbreviations hold. The following abbreviations are used to refer to the operating 1000i Series phone described in this Manual.

Table C: Abbreviation and acronym list

Acronym	Full name
AEM	Answering Machine Emulation
ACNR	Auto Called Number Redial
BGM	Background Music
BLF	Busy Lamp Field
BRI	Basic Rate Interface
CID	Calling Identity Delivery
CLI	Calling Line Identification
CLID	Calling Line ID
CLIP	Calling Line ID Presentation
CO	Central Office
COS	Class of Service
DID	Direct Inward Dialing
DND	Do Not Disturb
DSS	Direct Station Selection
DTMF	Dual Tone Multi-Frequency
HF	Hands-free
ICM	Intercom
IP	Internet Protocol
ISDN	Integrated Services Digital Network
LCD	Liquid Crystal Display
LED	Light Emitted Diode
LNR	Last Number Redial
LSS	LCD Station Selection
MWI	Message Wait Indication
PoE	Power over Ethernet
PRI	Primary Rate Interface
PTT	Push-To-Talk
PV	Privacy
SMDR	Station Message Detail Recording
SMS	Short Message Service
UMS	Unified Memory System

Acronym	Full name
UNA	Universal Night Answer
VMS	Virtual Memory System
VoIP	Voice over Internet Protocol

Appendix D: Open Source Software Notice

Open Source Software used in this product are listed as below. You can obtain a copy of the Open Source Software License from Ericsson-LG Enterprise Web site, <http://www.ericssonlg-enterprise.com>. Ericsson-LG Enterprise reserves the right to make changes at any time without notice.

Open Source	License
u-boot	GPL 2.0
linux	GPL 2.0
busybox	GPL 2.0
Alsa Libraries	LGPL
ortp	LGPL
pj_jbuf	GPL 2.0
ibsrtp	BSD
Curl/LibCurl	MIT
expat	MIT
wpa_supplicant	GPL 2.0
OpenLLDP	BSD
OpenVPN	GPL 2.0

Ericsson-LG Enterprise offers to provide you with open source code on CD-ROM for a charge covering the cost of performing such distribution, such as the cost of media, shipping and handling upon e-mail request to Ericsson-LG Enterprise at opensource@ericssonlg.com.

This offer is valid for a period of three (3) years from the date of the distribution of this product by Ericsson-LG Enterprise.

The contents of this document are subject to revision without notice due to continued progress in methodology design and manufacturing. Ericsson-LG Enterprise shall have no liability for any error or damage of any kind resulting from the use of this document.



Posted in Korea

www.ericssonlg-enterprise.com

© Ericsson-LG Enterprise Co., Ltd. 2019